

DAIKIN



OPERATION MANUAL

Packaged water-cooled water chillers

EWWP045KAW1M
EWWP055KAW1M
EWWP065KAW1M

ECB2MUAW
ECB3MUAW

CONTENTS

	<u>Page</u>
Introduction	1
Technical specifications	2
Electrical specifications	2
Description	3
Function of the main components.....	4
Safety devices.....	5
Internal wiring - Parts table	5
Before operation.....	6
Checks before initial start-up	6
Water supply	6
General recommendations	6
Operation 32~72 Hp.....	6
Digital controller.....	6
Working with the 32~72 Hp units.....	6
Advanced features of the digital controller.....	9
Troubleshooting.....	14
Maintenance.....	15
Important information regarding the refrigerant used	15
Maintenance activities	15
Disposal requirements.....	15

 **READ THIS MANUAL ATTENTIVELY BEFORE STARTING UP THE UNIT. DO NOT THROW THIS MANUAL AWAY. KEEP IT IN YOUR FILES FOR FUTURE REFERENCE.**
 Read the chapter "User settings menu" on page 9 before changing the parameters.

The English text is the original instruction. Other languages are translations of the original instructions.

This appliance is not intended for use by persons, including children, with reduced physical, sensory or mental capabilities, or lack of experience and knowledge, unless they have been given supervision or instruction concerning use of the appliance by a person responsible for their safety.

Children should be supervised to ensure that they do not play with the appliance.

INTRODUCTION

This operation manual concerns packaged water-cooled water chillers of the Daikin EWWP-KA series. These units are provided for indoor installation and used for cooling and/or heating applications. The units can be combined with Daikin fan coil units or air handling units for air conditioning purposes. They can also be used for supplying water for process cooling.

This manual has been prepared to ensure adequate operation and maintenance of the unit. It will tell you how to use the unit properly and will provide help if problems occur. The unit is equipped with safety devices, but they will not necessarily prevent all problems caused by improper operation or inadequate maintenance.

In case of persisting problems contact your local dealer.



Before starting up the unit for the first time, make sure that it has been properly installed. It is therefore necessary to carefully read the installation manual supplied with the unit and the recommendations listed in "Checks before initial start-up" on page 6.

Technical specifications⁽¹⁾

General		Hp	32	36	40	44	48	52	56	60	64	68	72	
Nominal cooling capacity ^(a)	(kW)		86	99	112	121	130	142	155	168	177	186	195	
Nominal input ^(b)	(kW)		24.2	28.1	32.0	34.3	36.6	40.2	44.1	48.0	50.3	52.6	54.9	
Dimensions HxWxD	(mm)		1200x600x1200						1800x600x1200					
Machine weight	(kg)		600	620	640	654	668	920	940	960	974	988	1002	
Connections														
• water inlet	(inch)		2x 2x G 1-1/2						3x 2x G 1-1/2					
• water outlet	(inch)		2x 2x G 1-1/2						3x 2x G 1-1/2					
Compressor														
Type			hermetically sealed scroll											
Qty x model			4x JT212DA-YE	2x JT212DA-YE + 2x JT300DA-YE	4x JT300DA-YE	2x JT300DA-YE + 2x JT335DA-YE	4x JT335DA-YE	4x JT212DA-YE + 2x JT300DA-YE	2x JT212DA-YE + 4x JT300DA-YE	6x JT300DA-YE	4x JT300DA-YE + 2x JT335DA-YE	2x JT300DA-YE + 4x JT335DA-YE	6x JT335DA-YE	
Speed	(rpm)		2900						2900					
Oil type			FVC 68D						FVC 68D					
Oil charge volume	(l)		4x 2.7						6x 2.7					
Evaporator														
Type			brased plate heat exchanger											
Qty			2						3					
Nominal water flow	(l/min)		247	284	321	347	373	407	444	482	507	533	559	
Water flow range	(l/min)		202 - 493	232 - 568	262 - 642	283 - 694	304 - 745	333 - 814	363 - 889	393 - 963	414 - 1015	435 - 1066	456 - 1118	
Condenser														
Type			brased plate heat exchanger											
Qty			2						3					
Nominal water flow	(l/min)		314	362	410	442	474	519	567	614	647	679	711	
Water flow range	(l/min)		157 - 629	181 - 724	205 - 819	221 - 883	237 - 948	260-1038	283-1133	307-1229	323-1293	339-1357	355-1422	

(a) The nominal cooling capacity is based on:

- entering water temperature of 12°C
- chilled water temperature of 7°C
- condenser in/out water temperature of 30/35°C

(b) The nominal input includes total input of the unit: compressor, control circuit and water pumps.

Electrical specifications⁽¹⁾

General		Hp	32	36	40	44	48	52	56	60	64	68	72	
Power supply														
• Phase			3N~						3N~					
• Frequency	(Hz)		50						50					
• Voltage	(V)		400						400					
• Voltage tolerance	(%)		±10						±10					
Unit														
• Nominal running current	(A)		41.6	47.0	52.4	56.2	60.0	67.8	73.2	78.6	82.4	86.2	90.0	
• Maximum running current	(A)		56	64	72	76	80	92	100	108	112	116	120	
• Recommended fuses according to IEC 269-2	(A)		3x 63	3x 63	3x 80	3x 80	3x 80	3x 100	3x 100	3x 125	3x 125	3x 125	3x 125	
Compressor														
• Phase			3~						3~					
• Frequency	(Hz)		50						50					
• Voltage	(V)		400						400					
• Nominal running current	(A)		10.4	10.4/13.1	13.1	13.1/15	15	10.4/13.1	10.4/13.1	13.1	13.1/15	13.1/15	15	

(1) Refer to the engineering data book for the complete list of specifications.

DESCRIPTION

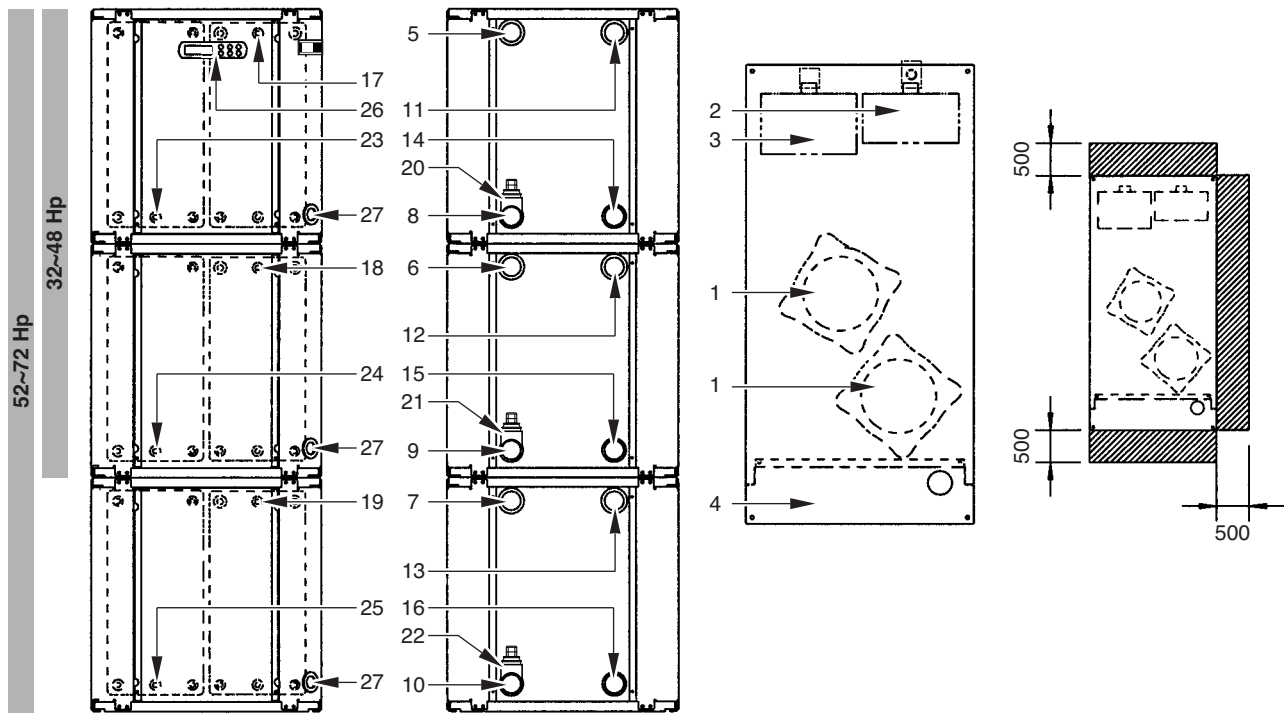

Figure - Main components

- | | | | |
|----|-----------------------|----|--|
| 1 | Compressor | 15 | Condenser water in 2 |
| 2 | Evaporator | 16 | Condenser water in 3 |
| 3 | Condenser | 17 | Evaporator entering water temperature sensor 1 |
| 4 | Switchbox | 18 | Evaporator entering water temperature sensor 2 |
| 5 | Chilled water in 1 | 19 | Evaporator entering water temperature sensor 3 |
| 6 | Chilled water in 2 | 20 | Freeze up sensor 1 |
| 7 | Chilled water in 3 | 21 | Freeze up sensor 2 |
| 8 | Chilled water out 1 | 22 | Freeze up sensor 3 |
| 9 | Chilled water out 2 | 23 | Condenser entering water temperature sensor 1 |
| 10 | Chilled water out 3 | 24 | Condenser entering water temperature sensor 2 |
| 11 | Condenser water out 1 | 25 | Condenser entering water temperature sensor 3 |
| 12 | Condenser water out 2 | 26 | Digital display controller 32~72 Hp |
| 13 | Condenser water out 3 | 27 | Power supply intake |
| 14 | Condenser water in 1 | | |
- Required space around the unit for service

Function of the main components

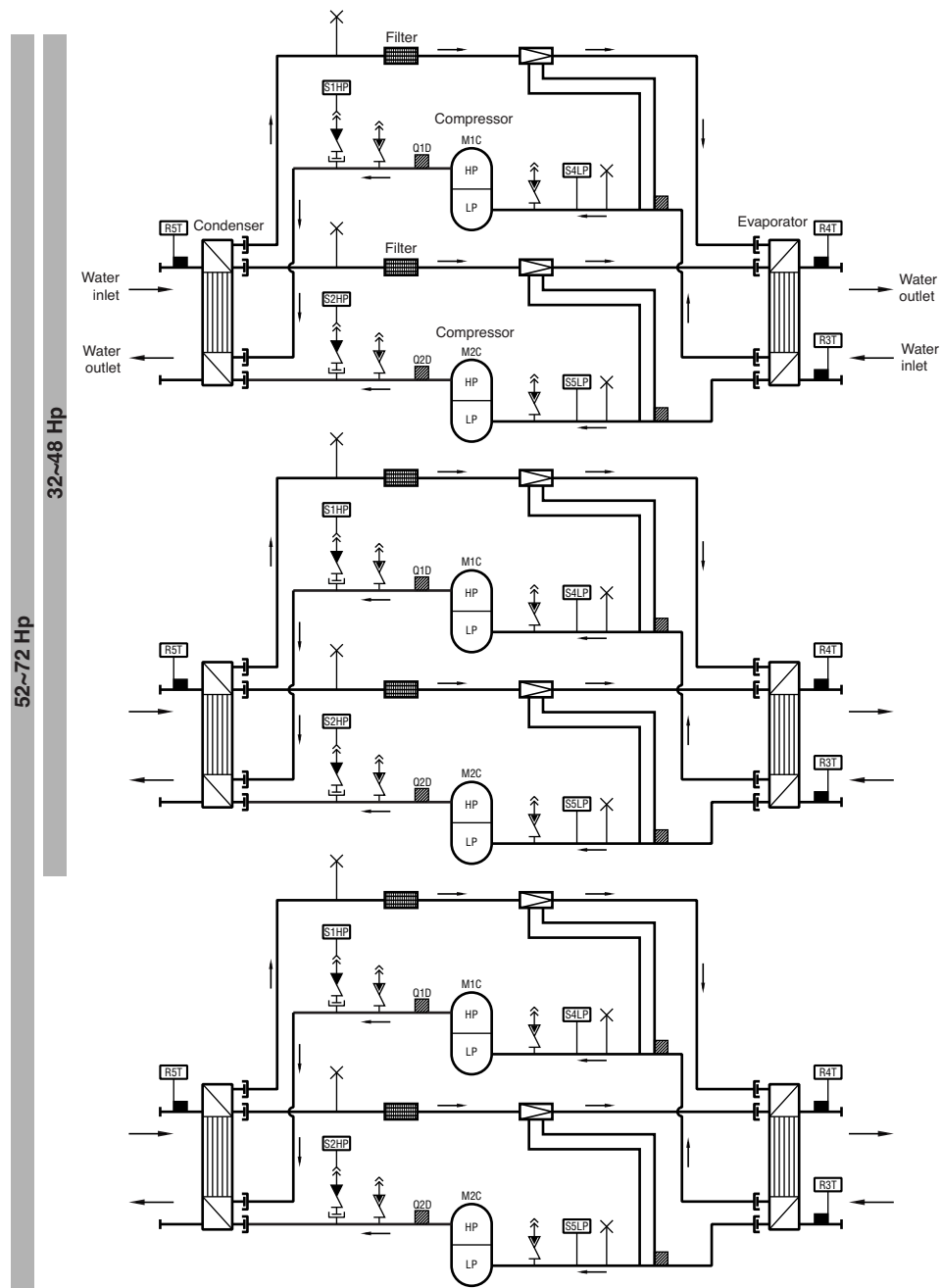

Figure - Functional diagram

As the refrigerant circulates through the unit, changes in its state or condition occur. These changes are caused by the following main components:

- **Compressor**
The compressor (M^{*}C) acts as a pump and circulates the refrigerant in the refrigeration circuit. It compresses the refrigerant vapour coming from the evaporator to a pressure at which it can easily be liquified in the condenser.
- **Condenser**
The function of the condenser is to change the state of the refrigerant from gaseous to liquid. The heat gained by the gas in the evaporator is discharged through the condenser and the vapour condenses to liquid.
- **Filter**
The filter installed behind the condenser removes small particles from the refrigerant to prevent blockage of the tubes.
- **Expansion valve**
The liquid refrigerant coming from the condenser enters the evaporator via an expansion valve. The expansion valve brings the liquid refrigerant to a pressure at which it can easily be evaporated in the evaporator.
- **Evaporator**
The main function of the evaporator is to take heat from the water that flows through it. This is done by turning the liquid refrigerant, coming from the condenser, into gaseous refrigerant.
- **Water inlet/outlet connection**
The water inlet and outlet connections allow an easy connection of the unit to the water circuit of the air handling unit or industrial equipment.

Safety devices

Overcurrent relay

The overcurrent relay (K*S) is located in the switch box of the unit and protects the compressor motor in case of overload, phase failure or too low voltage. The relay is factory-set and may not be adjusted. When activated, the overcurrent relay has to be reset in the switch box and the controller needs to be reset manually.

High-pressure switch

The high-pressure switch (S*HP) is installed on the discharge pipe of the unit and measures the condenser pressure (pressure at the outlet of the compressor). When the pressure is too high, the pressure switch is activated and the circuit stops. When activated, it resets automatically, but the controller needs to be reset manually.

Low pressure switch

The low-pressure switch (S*LP) is installed on the suction pipe of the unit and measures the evaporator pressure (pressure at the inlet of the compressor). When the pressure is too low, the pressure switch is activated and the circuit stops. When activated, it resets automatically, but the controller needs to be reset manually.

Reverse phase protector

The reverse phase protector (R1P) is installed in the switch box of the unit. It prevents the compressor from running in the wrong direction. If the unit does not start, two phases of the power supply must be inverted.

Discharge thermal protector

The discharge thermal protector (Q*D) is activated when the temperature of the refrigerant leaving the compressor becomes too high. When the temperature returns to normal, the protector resets automatically, but the controller needs to be reset manually.

Freeze-up protection

The freeze-up protection prevents the water in the evaporator from freezing during operation. When the outlet water temperature is too low, the controller disables the circuit. When the outlet water temperature returns to normal, the circuit can start up again.

When freeze-up protection occurs several times in a certain period, the freeze-up alarm will be activated and the circuit will be shut down. The cause of freezing up should be investigated and after outlet water temperature has risen enough, the alarm indicator on the controller needs to be reset manually.

Additional interlock contact

To avoid that the unit could be started or run without water circulating through the water heat exchanger, an interlock contact (S11L) of e.g. a flow switch must be installed in the start-up circuit of the unit.

Internal wiring - Parts table

Refer to the internal wiring diagram supplied with the unit. The abbreviations used are listed below:

A1P	PCB terminal unit
A2P	** ...PCB address card
F1,2,3U	#Main fuses for the unit
F5B,F6B	Automatic fuse for the control circuit/secondary of TR1
F8U	Surge-proof fuse
F9U	## ...Surge-proof fuse
H1P	*Indication lamp alarm
H3P	*Indication lamp operation compressor (M1C)
H4P	*Indication lamp operation compressor (M2C)
K1A	auxiliary contactor for high pressure
K1M	Compressor contactor (M1C)
K1P	*Pumpcontactor
K2M	Compressor contactor (M2C)

K4S	Overcurrent relay (M1C)
K5S	Overcurrent relay (M2C)
K19T	Timer, time delay for M2C
M1C,M2C	Compressor motor
PE	Main earth terminal
Q1D	Discharge thermal protector (M1C)
Q2D	Discharge thermal protector (M2C)
R1P	Reverse phase protector
R3T	Evaporator inlet water temperature sensor
R4T	Evaporator outlet water temperature sensor (Freeze up sensor)
R5T	Condenser inlet temperature sensor
S1HP,S2HP	High pressure switch
S4LP,S5LP	Low pressure switch
S7S	Changeable digital input 1
S9S	*Changeable digital input 2
S10L	#Flowswitch
S11L	#Contact that closes if the pump is working
S12S	#Main isolator switch
TR1	Transfo 230 V → 24 V for power supply of controllers
Y1R	Reversing valve
Y1S	Solenoid valve for injection line
X1	Connector for digital inputs, analog inputs, analog outputs and for power supply controller (A1P)
X2	Connector for digital outputs (A1P)
X3	Connector for (A1P)
X4,X5,X6	Interconnection connector Main ↔ Control switchbox

	Not included with standard unit	
	Not possible as option	Possible as option
Obligatory	#	##
Not obligatory	*	**

Terminal unit: Digital Inputs

X1 (ID1-GND)	flowswitch
X1 (ID2-GND)	remote cooling/heating selection
X1 (ID3-GND)	high pressure switch + discharge protector + overcurrent
X1 (ID4-GND)	low pressure switch
X1 (ID5-GND)	remote On/Off

Terminal unit: Digital outputs (relays)

X2 (C1/2-NO1)	compressor M1C on
X2 (C1/2-NO2)	compressor M2C on
X2 (C3/4-NO3)	voltage free contact for pump
X2 (C3/4-NO4)	voltage free contact for reversing valve
X2 (C5-NO5)	alarm voltage free contact

Terminal unit: Analog inputs

X1 (B1-GND)	evaporator inlet water temperature
X1 (B2-GND)	evaporator outlet water temperature (Freeze up sensor)
X1 (B3-GND)	condenser inlet water temperature

BEFORE OPERATION

Checks before initial start-up



Make sure that the circuit breaker on the power supply panel of the unit is switched off.

After the installation of the unit, check the following before switching on the circuit breaker:

- 1 Field wiring**
Make sure that the field wiring between the local supply panel and the unit has been carried out according to the instructions described in the installation manual, according to the wiring diagrams and according to European and national regulations.
- 2 Additional interlock contact**
An additional interlock contact S11L should be provided (e.g. flow switch, contact of pump motor contactor). Make sure that it has been installed between the appropriate terminals (refer to the wiring diagram supplied with the unit). S11L should be a normal open contact.
- 3 Fuses or protection devices**
Check that the fuses or the locally installed protection devices are of the size and type specified in the installation manual. Make sure that neither a fuse nor a protection device has been bypassed.
- 4 Earth wiring**
Make sure that the earth wires have been connected properly and that the earth terminals are tightened.
- 5 Internal wiring**
Visually check the switch box on loose connections or damaged electrical components.
- 6 Fixation**
Check that the unit is properly fixed, to avoid abnormal noises and vibrations when starting up the unit.
- 7 Damaged equipment**
Check the inside of the unit on damaged components or squeezed pipes.
- 8 Refrigerant leak**
Check the inside of the unit on refrigerant leakage. If there is a refrigerant leak, call your local dealer.
- 9 Oil leak**
Check the compressor on oil leakage. If there is an oil leak, call your local dealer.
- 10 Power supply voltage**
Check the power supply voltage on the local supply panel. The voltage should correspond to the voltage on the identification label of the unit.

Water supply

Fill the water piping, taking into account the minimum water volume required by the unit. Refer to the "installation manual".

Make sure that the water is of the quality as mentioned in the installation manual.

Purge the air at the high points of the system and check the operation of the circulation pump and the flow switch.

General recommendations

Before switching on the unit, read following recommendations:

- 1** When the complete installation and all necessary settings have been carried out, close all front panels of the unit.
- 2** The service panels of the switch boxes may only be opened by a licensed electrician for maintenance purposes.

OPERATION 32~72 HP

The 32~72 Hp units are equipped with a built-in digital controller offering a user-friendly way to set up, use and maintain the unit.

This part of the manual has a task-oriented, modular structure. Apart from the first section, which gives a brief description of the controller itself, each section or subsection deals with a specific task you can perform with the unit.

Depending on the model there are two or three modules in the system. The models 32~48 Hp only have two modules, whereas the models 52~72 Hp consist of three modules. These modules are generally named M1, M2 and M3 in the following descriptions. All information about module 3 (M3) is not applicable for 32~48 Hp models.

Digital controller

User interface

The digital controller consists of an alphanumeric display, labelled keys which you can press and a number of LEDs.

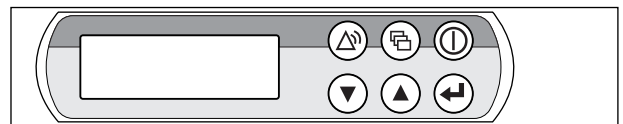

Figure - Digital controller

- key, to enter the main menu
- key, to start up or to shut down the unit.
- key, to enter the safeties menu or to reset an alarm.
- keys, to scroll up or down through the screens of a menu (only in case Δ , ∇ or \div appears) or to raise, respectively lower a setting.
- key, to confirm a selection or a setting.

NOTE Temperature readout tolerance: $\pm 1^{\circ}\text{C}$.



Legibility of the alphanumeric display may decrease in direct sunlight.

Working with the 32~72 Hp units

This chapter deals with the everyday usage of the unit. Here, you will find how to perform routine tasks, such as:

- "Setting the language" on page 7
- "Switching the unit on" on page 7 and "Switching the unit off" on page 7
- "Consulting actual operational information" on page 7
- "Selecting cooling or heating operation" on page 8
- "Adjusting the temperature setpoint" on page 8
- "Resetting the unit" on page 8

Setting the language

If desired, the operating language can be changed to any of the following languages: English, German, French, Spanish or Italian.

- 1 Enter the usersettings menu. Refer to chapter "Main menu" on page 9
- 2 Go to the appropriate screen of the usersettings menu using the \blacktriangle and \blacktriangledown keys.
- 3 Select the appropriate field (LANGUAGE) using the \odot key.
- 4 Press the \blacktriangle and \blacktriangledown keys to adjust the language setting.
- 5 Press \odot to confirm the adjusted language setting.

When the setting has been confirmed, the cursor switches to the next setting.

Switching the unit on

- 1 Press the \odot key on the controller.

Depending on whether or not the remote ON/OFF switch is configured (refer to the service manual), the following conditions may occur.

When no remote ON/OFF switch is configured, the LED inside the \odot key lights up and an initialization cycle is started. Once all the timers have reached zero, the unit starts up.

When a remote ON/OFF switch is configured, the following table applies:

Local key	Remote switch	Unit	\odot LED
ON	ON	ON	ON
ON	OFF	OFF	Flashing
OFF	ON	OFF	OFF
OFF	OFF	OFF	OFF

- 2 When the unit is started up for the first time, or when the unit has been out of operation for a longer period, it is recommended to check the following.

Abnormal noise and vibrations

Make sure that the unit does not produce abnormal noises or vibrations: check the fixation, stop valves and piping. If the compressor makes abnormal noises, this may also be caused by an overcharge of refrigerant.

- 3 If the water chiller does not start after a few minutes, refer to "Troubleshooting" on page 14.

Switching the unit off

If the remote on/off control parameter is set to NO:

Press the \odot key on the controller.
The LED inside the \odot key goes out.

If the remote on/off control parameter is set to YES:

Press the \odot key on the controller or switch the unit off using the remote on/off switch.
The LED inside the \odot key goes out in the first case and starts blinking in the second case.



In case of emergency, switch off the unit by pushing the emergency stopbutton.

NOTE

Also consult "Defining the schedule timer" on page 12.



Consulting actual operational information

- 1 Enter the readout menu through the main menu. (Refer to the chapter "Main menu" on page 9.)

The controller automatically shows the first screen of the readout menu which provides the following information:

- MANUAL MODE or INLSETP1/2: manual/automatic control mode operation. If the automatic control mode is selected, the controller will indicate the active temperature setpoint. Depending on the status of the remote contact, setpoint one or setpoint two is active.
- INL WATER E/C: actual inlet water temperature.
- THERMOSTAT STEP: actual thermostat step. The maximum number of thermostat steps are as listed:

32 Hp	4	48 Hp	4	64 Hp	6
36 Hp	4	52 Hp	6	68 Hp	6
40 Hp	4	56 Hp	6	72 Hp	6
44 Hp	4	60 Hp	6		

- 2 Press the \blacktriangledown key to enter the next screen of the readout menu.

This screen of the readout menu provides the following information on the evaporator:

- M1: OUTWATER: actual outlet water temperature of module 1.
- M2: OUTWATER: actual outlet water temperature of module 2.
- M3: OUTWATER: actual outlet water temperature of module 3.

- 3 Press the \blacktriangledown key to enter the next screen of the readout menu.

The COMPRESSOR STATUS screen of the readout menu provides information concerning the status of the different compressors.

- C11: actual status of compressor 1 of module 1.
- C12: actual status of compressor 2 of module 1.
- C21: actual status of compressor 1 of module 2.
- C22: actual status of compressor 2 of module 2.
- C31: actual status of compressor 1 of module 3.
- C32: actual status of compressor 2 of module 3.

When a circuit is OFF, the following status information may appear.

- SAFETY ACTIVE: one of the circuit safety devices is activated (refer to the chapter "Troubleshooting" on page 14).
- LIMIT: the circuit is limited by a remote contact.
- TIMERS BUSY: the actual value of one of the software timers is not zero (refer to the "Timers menu" on page 9).
- CAN STARTUP: the circuit is ready to start up when extra cooling load is needed.

The preceding OFF messages are written down in order of priority. If one of the timers is busy and one of the safeties is active, the status information says SAFETY ACTIVE.

- 4 Press the \blacktriangledown key to enter the next screen of the readout menu.

To consult actual operational information about the total running hours of the compressors.





Selecting cooling or heating operation

The "cooling/heating" menu allows the user to set the unit in cooling or heating operation.

The COOL/HEAT menu provides information concerning the selected operation mode.

- COOLING (EVAP): cooling mode. The two setpoints for inlet water temperature control of the evaporator can be used.
- HEATING (COND): heating mode. The two setpoints for inlet water temperature control of the condenser can be used.

To define cooling/heating operation, proceed as follows:

- 1 Enter the cooling/heating menu through the main menu. (Refer to the chapter "Main menu" on page 9.)
- 2 Position the cursor behind FCODE using the  key.
- 3 Select the appropriate setting using the  and  keys.
- 4 Press  to confirm.
The cursor returns to the upper left corner of the screen.

Adjusting the temperature setpoint

The unit provides definition and selection of four or two independent temperature setpoints.

In cooling operation, two setpoints are reserved for inlet control of the evaporator.

- INLSETP1E: inlet water temperature of evaporator, setpoint 1,
- INLSETP2E: inlet water temperature of evaporator, setpoint 2.

In heating operation, two setpoints are reserved for inlet control of the condenser.

- INLSETP1C: inlet water temperature of condenser, setpoint 1,
- INLSETP2C: inlet water temperature of condenser, setpoint 2.





In double thermostat operation, two setpoints are reserved for inlet control of the evaporator and two others are reserved for inlet control of the condenser.



- INLSETP1E: inlet water temperature of evaporator, setpoint 1,
- INLSETP2E: inlet water temperature of evaporator, setpoint 2.
- INLSETP1C: inlet water temperature of condenser, setpoint 1,
- INLSETP2C: inlet water temperature of condenser, setpoint 2.

The selection between setpoint 1 and 2 is done by a remote dual setpoint switch (to be installed by the customer). The actual active setpoint can be consulted in the readout menu.

If the manual control mode is selected (refer to "User settings menu" on page 9), none of the above-mentioned setpoints will be active.

To adjust a setpoint, proceed as follows:

- 1 Enter the setpoints menu through the main menu. (Refer to the chapter "Main menu" on page 9).
If the user password is disabled for setpoint modifications (refer to the "User settings menu" on page 9), the controller will immediately enter the setpoints menu.
If the user password is enabled for setpoint modifications, enter the correct code using the  and  keys. (Refer to the "User password menu" on page 10). Press  to confirm the password and to enter the setpoints menu.
- 2 Select the setpoint to be adjusted using the  key.
A setpoint is selected when the cursor is blinking behind the setpoint's name.
The ">" sign indicates the actual active temperature setpoint.

- 3 Press the  and  keys to adjust the temperature setting.
The default, limit and step values for the cooling (evaporator) and heating (condenser) temperature setpoints are:

	INLSETP1E	INLSETP1C
default value	12°C	30°C
limit values ^(a)	8 --> 23°C	15 --> 50°C
step value	0.1°C	0.1°C

(a) For glycol units the lower limit of the cooling temperature setpoint can be adapted in the factory. The following values apply:
INLSETP1E/C: 5°C, 3°C, -2°C, -7°C

- 4 Press  to save the adjusted temperature setpoint.
When the setting has been confirmed, the cursor switches to the next setpoint.
- 5 To adjust other setpoints, repeat from instruction 2 onwards.

NOTE Also consult "Defining the schedule timer" on page 12.



Resetting the unit







The units are equipped with three kinds of safety devices: unit safeties, module safeties and network safeties.

When a unit safety occurs, all compressors are shut down. The safeties menu will indicate which safety is activated. The COMPRESSOR STATUS screen of the readout menu will indicate OFF - SAFETY ACTIVE for all circuits. The red LED inside the  key lights up and the buzzer inside the controller is activated.

When a module safety occurs, the compressors of the corresponding module are shut down. The COMPRESSOR STATUS screen of the readout menu will indicate OFF - SAFETY ACTIVE for the module concerned. The red LED inside the  key lights up and the buzzer inside the controller is activated.

If the unit has been shut down due to a power failure, it will carry out an autoreset and restart automatically when the electrical power is restored.

To reset the unit, proceed as follows:

- 1 Press the  key to acknowledge the alarm.
The buzzer is deactivated.
The controller automatically switches to the corresponding screen of the safeties menu: unit safety or module safety.
- 2 Find the cause of shutdown and correct.
Refer to "Listing activated safeties and checking the unit status" on page 12 and the chapter "Troubleshooting" on page 14.
When a safety can be reset, the LED under the  key starts blinking.
- 3 Press the  key to reset the safeties that are no longer active.
Once all safety devices are deactivated and reset, the LED under the  key goes out. If one of the safeties is still active, the LED under the  key goes on again. In this case, return to instruction 2.
- 4 If a unit safety occurred or if all modules were shut down due to module safeties, switch on the unit using the  key.



If the user shuts down the power supply in order to repair a safety, the safety will automatically be reset after power-up.

NOTE



The history information, i.e. the number of times a unit safety or a circuit safety occurred and the unit status at the moment of shutdown, can be checked by means of the history menu.

Advanced features of the digital controller

This chapter gives an overview and a brief functional description of the screens provided by the different menus. In the following chapter, you will find how you can set up and configure the unit using the various menu functions.

The down arrow ↓ on the display indicates that you can go to the next screen of the current menu using the ⏴ key. The up arrow ↑ on the display indicates that you can go to the previous screen of the current menu using the ⏵ key. If ⇄ is displayed, this indicates that you can either return to the previous screen or can go to the next screen by using the ⏴ and ⏵ keys.

Main menu

Scroll through the main menu using the ⏴ and ⏵ keys to move the > mark in front of the menu of your choice. Push the ⏴ key to enter the selected menu.

```

>READOUT MENU
SETPOINTS MENU
USERSETTINGS MENU
TIMERS MENU
HISTORY MENU
INFO MENU
I/O STATUS MENU
USERPASSWORD MENU
COOL/HEAT MENU
    
```

Readout menu

```

↓ MANUAL MODE
INL WATER E: 12.0°C
INL WATER C: 30.0°C
THERMOSTAT STEP: 2/6
    
```

To consult actual operational information about the control mode, the inlet water temperature of the evaporator/condenser and the thermostat step.

```

⇄ EVAPORATOR
M1: OUTWATER: 07.0°C
M2: OUTWATER: 07.0°C
M3: OUTWATER: 03.0°C
    
```

To consult information about the outlet water temperature of the modules 1, 2 and 3 (only for 52~72 Hp).

```

⇄ COMPRESSOR STATUS
C11: OFF-CAN STARTUP
C12: OFF-CAN STARTUP
C21: OFF-CAN STARTUP
    
```

To consult information about the compressor status (first screen).

```

⇄ COMPRESSOR STATUS
C22: OFF-CAN STARTUP
C31: OFF-SAFETY ACT.
C32: OFF-LIMIT
    
```

To consult information about the compressor status (second screen).

```

⇄ RUNNING HOURS
C11: 00010h 12: 00010h
C21: 00010h 22: 00010h
C31: 00010h 32: 00010h
    
```

To consult actual operational information about the total running hours of the compressors.

Setpoints menu

Depending upon the settings in the user settings menu and on the selected cooling/heating operation mode, the "setpoints" menu can either be entered directly or by means of the user password.

```

>INLSETP1 E: 12.0°C
INLSETP2 E: 12.0°C
INLSETP1 C: 30.0°C
INLSETP2 C: 30.0°C
    
```

To define the temperature setpoints.

User settings menu

The "user settings" menu, protected by the user password, allows a full customization of the units.

```

⇄ CONTROL SETTINGS
MODE: MANUAL CONTROL
C11: OFF 12: OFF
C21: OFF 22: OFF
    
```

To define the manual settings and to select the control mode.

```

⇄ THERMOST. SETTINGS
STEPS: 6 STPL: 1.5°C
STEPDIFFERENCE: 0.5°C
LOADUP: 180s-DWN: 30s
    
```

To define the thermostat settings.

```

⇄ LEAD-LAG SETTINGS
LEAD-LAG MODE: AUTO
LEAD-LAG HOURS: 1000h
    
```

To define the lead-lag mode of the modules.

```

⇄ CAP. LIM. SETTINGS
MODE: REMOTE DIG INP.
L1M1: OFF 2: OFF 3: OFF
L2M1: OFF 2: OFF 3: OFF
    
```

To define capacity limitation. (first screen)

```

⇄ CAP. LIM. SETTINGS
L3M1: OFF 2: OFF 3: OFF
L4M1: OFF 2: OFF 3: OFF
    
```

To define capacity limitation. (second screen)

```

⇄ PUMP CONTROL
PUMPLEADTIME: 020s
PUMPLAGTIME: 000s
DAILY ON: Y AT: 00H00
    
```

To define the pump control settings.

```

⇄ SCHEDULE TIMER
ENABLE TIMER: N
ENABLE HOLIDAY PER: N
    
```

To define the schedule timer.

```

⇄ HOLIDAY: 01 TO 03
1: 00H00 -
2: 00H00 -
3: 00H00 -
    
```

To define the holiday settings.

```

⇄ DUAL EVAP. PUMP
MODE: AUTON. ROTATION
OFFSET ON RH: 0048h
    
```

To define the dual evaporator pump.

```

⇄ DISPLAY SETTINGS
LANGUAGE: ENGLISH
TIME: 00H00
DATE: 00/01/2001
    
```

To define the display settings.

```

⇄ SETPOINT PASSWORD
PASSWORD NEEDED TO
CHANGE SETPOINTS: Y
    
```

To define whether or not a password is needed to enter the setpoints menu.

```

⇄ ENTER SERVICE
PASSWORD: 0000
    
```

To enter the service menu. (Only a qualified installer is allowed to access this menu.)

Timers menu

```

↓ GENERAL TIMERS
LOADUP: 000s - DWN: 000s
PUMPLEAD: 000s
FLOWSTOP: 00s
    
```

To check the actual value of the general software timers (first screen).

```

⇄ COMPRESSOR TIMERS
COMPR. STARTED: 00s
    
```

To check the actual value of the general software timers (second screen).

```

⇄ COMPRESSOR TIMERS
C11 GRD: 000s AR: 000s
C12 GRD: 000s AR: 000s
C21 GRD: 000s AR: 000s
    
```

To check the actual value of the compressor timers (first screen).

```

    ^ COMPRESSOR TIMERS
C22 GRD: 000s AR: 000s
C31 GRD: 000s AR: 000s
C32 GRD: 000s AR: 000s
  
```

To check the actual value of the compressor timers (second screen).

Safeties menu

The "safeties" menu provides useful information for trouble shooting purposes. The following screens contain basic information.

```

    V UNIT SAFETY
OC9: INL E SENSOR ERR
  
```

To consult which unit safety caused the shutdown.

```

    V MODULE 1 SAFETY
ICA: OUT E SENSOR ERR
  
```

To consult which module 1 safety caused the shutdown.

```

    V MODULE 2 SAFETY
PCA: OUT E SENSOR ERR
  
```

To consult which module 2 safety caused the shutdown.

```

    V MODULE 3 SAFETY
3CA: OUT E SENSOR ERR
  
```

To consult which module 3 safety caused the shutdown.

Along with the basic information, more detailed information screens can be consulted while the safety menu is active. Press the \odot key. Screens similar to the following will appear.

```

    + UNIT HISTORY: 004
OC9: INL E SENSOR ERR
00h00 - 12/01/2001
ANNUAL MODE
  
```

To check the time and control mode at the moment of the unit shutdown.

```

    + UNIT HISTORY: 004
OC9: INL E SENSOR ERR
INLE: 12.0°C STEP:
INLC: 30.0°C 0
  
```

To check which were the common evaporator and condenser inlet water temperature.

```

    + UNIT HISTORY: 004
OC9: INL E SENSOR ERR
OUTE1: 07.0°C OUTE3:
OUTE2: 07.0°C 07.0°C
  
```

To check which were the evaporator outlet water temperature of all modules at the moment of shutdown.

```

    + UNIT HISTORY: 004
OC9: INL E SENSOR ERR
C11: ON C21:
C12: ON ON
  
```

To check which was the status of the compressors at the moment of shutdown (first screen).

```

    + UNIT HISTORY: 004
OC9: INL E SENSOR ERR
C22: ON
  
```

To check which was the status of the compressors at the moment of shutdown (second screen).

```

    + UNIT HISTORY: 004
OC9: INL E SENSOR ERR
RH11: 00000h RH21:
RH12: 00000h 00000h
  
```

To check which were the total amount of running hours of the compressors at the moment of shutdown (first screen).

```

    + UNIT HISTORY: 004
OC9: INL E SENSOR ERR
RH22: 00000h
  
```

To check which were the total amount of running hours of the compressors at the moment of shutdown (second screen).

History menu

The "history" menu contains all the information concerning the latest shutdowns. The structure of those menus is identical to the structure of the safeties menu. Whenever a failure is solved and the operator performs a reset, the concerning data from the safeties menu is copied into the history menu. Warnings are also recorded.

Additionally the number of safeties that already occurred, can be consulted on the first line of the history screens.

Info menu

```

    V TIME INFORMATION
TIME : 00h00
DATE : 00/01/2001
  
```

To consult time and date information.

```

    + UNIT INFORMATION
UNITTYPE : UU-HP-32
MANUFACT. NR.: 0000000
REFRIGERANT : R134A
  
```

To consult additional information about the unit such as the unit type, the refrigerant used and the manufacturing number.

```

    + UNIT INFORMATION
SW : V1.016 (01/11/01)
SW CODE : FLDKMNCHOR
  
```

To consult information about the controller's software version.

```

    ^ PCB INFORMATION
BOOT : V2.02-02/08/00
BIOS : V2.32-31/07/01
  
```

To consult information about the PCB.

Input/output menu

The "input/output" menu gives the status of all the digital inputs and the relay outputs of the unit.

```

    V DIGITAL INPUTS
M1 SAFETY OK
M2 SAFETY OK
M3 SAFETY OK
  
```

To check whether any module safeties are active.

```

    + DIGITAL INPUTS
FLOWSWITCH : FLOW OK
REV.PHASE PR. : OK
  
```

To check the reverse phase protector and if there's any waterflow to the evaporator.

```

    + CHANG. DIG. INPUTS
D01 DUAL SETP: SETP.}
D02 REA. ON/OFF: OFF
D03 REA. C/H: COOL
  
```

To check the status of the changeable digital inputs.

```

    + RELAY OUTPUTS
C11 : ON C12 : ON
C21 : ON C22 : ON
C31 : ON C32 : OFF
  
```

To check the status of the compressor relay outputs.

```

    + RELAY OUTPUTS
LPBYPASS1 : CLOSED
LPBYPASS2 : CLOSED
LPBYPASS3 : OPEN
  
```

To check the status of the modules low pressure bypass.

```

    + RELAY OUTPUTS
GEN. ALARM : CLOSED
PUMP/GEN OPER: CLOSED
  
```

To check the status of the alarm voltage free contact and the pump/general operation contact.

```

    ^ CHANG. REL OUTPUTS
D01 REV.VALVE(C/H) : 0
  
```

To check the status of the changeable relay output.

User password menu

```

    - CHANGE PASSWORD
NEW PASSWORD : 0000
CONFIRM : 0000
  
```

To change the user password.

Cooling/heating menu

```



    - COOLING/HEATING
MODE : COOLING (EVAP)
  
```

To select cooling or heating mode.







Tasks of the user settings menu

Entering the user settings menu

The user settings menu is protected by the user password, a 4-digit number between 0000 and 9999.

- 1 Enter the USERSETTINGS MENU through the main menu. (Refer to the chapter "Main menu" on page 9).
The controller will request the password.
- 2 Enter the correct password using the  and  keys.
- 3 Press  to confirm the password and to enter the user settings menu.
The controller automatically enters the first screen of the user settings menu.

To define settings of a certain function:

- 1 Go to the appropriate screen of the usersettings menu using the  and  keys.
- 2 Position the cursor behind the parameter to be modified using the  key.
- 3 Select the appropriate setting using the  and  keys.
- 4 Press  to confirm the selection.
When the selection has been confirmed, the cursor switches to the next parameter which can now be modified.
- 5 Repeat from instruction 2 onwards to modify the other parameters.

Defining and activating the control mode

The unit is equipped with a thermostat which controls the cooling capacity of the unit. Two different control modes exist:

- manual control mode: the operator controls the capacity himself - MANUAL CONTROL
- inlet control mode: uses the evaporator and/or condenser entering water temperature to control the capacity of the unit - INLET WATER

When the operator wants to control the capacity himself, he can activate manual control mode using the CONTROL SETTINGS screen of the user settings menu. In this case, he has to define the following parameters:

- MODE (present mode): manual control.
- C1, C2, C21, C22, C31, C32 (compressor status of module 1, 2 and 3 in manual mode or capacity limitation value in case the "capacity limitation remote contact" is enabled): ON or OFF.

NOTE  To activate manual control mode, select MANUAL as present mode. To deactivate the manual control mode, select INLET WATER as present mode.

Defining the thermostat settings

When automatic control mode is selected, the unit uses a thermostat to control the cooling or heating capacity. The maximum number of thermostat steps are as listed:

32 Hp	4	48 Hp	4	64 Hp	6
36 Hp	4	52 Hp	6	68 Hp	6
40 Hp	4	56 Hp	6	72 Hp	6
44 Hp	4	60 Hp	6		

However, the thermostat parameters are not fixed and can be modified via the THERMOST. SETTINGS screen of the user settings menu.

The default, limit and step values for the thermostat parameters are:

	Lower limit	Upper limit	Step	Default
STPL (°C)	0.4	2.0	0.1	1.5
STEPDIFFERENCE (°C)	0.2	0.8	0.1	0.5
LOADUP (sec)	15	300	1	180
LOADDOWN (sec)	15	300	1	20

NOTE  A functional diagram showing the thermostat parameters can be found in "Annex I" on page 16.

Defining the lead-lag mode

The lead/lag mode determines which module starts up first in case of a capacity demand.

The lead-lag parameters are:

- LEAD-LAG MODE
Automatic: the controller decides whether module 1, module 2, or module 3 starts up first.
The modules follow the entered order of starting up (see table below).

3 modules			2 modules	
first	>	next >	last	
1		2		3
2		3		1
3		1		2

NOTE  If a module is de-activated due to a failure, the next module will start up instead.

- LEAD-LAG HOURS: In the automatic mode, the number of hours indicated on the display is the maximum difference between the running hours of the modules. This value is important for maintenance purposes. It should be set high enough so that the modules do not require maintenance at the same time and that at least one module can remain constantly active.
The lower and upper limits are 100 and 1000 hours respectively. The default value is 1000 hours.

Defining the pump control settings

The PUMPCONTROL screen of the user settings menu allows the user to define the pump-leadtime and pump-lagtime.

- PUMPLEADTIME: used to define the time that the pump must run before the unit can start up.
- PUMPLAGTIME: used to define the time that the pump keeps running after the unit has been stopped.

Defining the display settings

The DISPLAY SETTINGS screen of the user settings menu allows the user to define the choice of language, time and date.

- LANGUAGE: used to define the language of the displayed information of the controller.
- TIME: used to define the present time.
- DATE: used to define the present date.

Defining dual evaporator pump control

The DUAL EVAP. PUMP screen of the user settings menu allows the user to define the steering of two evaporator pumps (for this to be possible a changeable digital output has to be configured for a second evaporator pump in the service menu).

- **MODE:** used to define which kind of control will be used for the two evaporator pumps. When automatic rotation is chosen the offset on running hours also has to be entered.
- **OFFSET ON RH:** used to define the offset in running hours between the two pumps. Used to switch over between pumps when they work in automatic rotation mode.

Defining the schedule timer

The SCHEDULE TIMER screen of the user settings menu allows the user to define the schedule timer settings.

- **MON, TUE, WED, THU, FRI, SAT and SUN:** used to define to which group each day of the week belongs (-/G1/G2/G3/G4).
- For each of the four groups up to nine actions can be set, each with their respective timing. Actions include: putting the unit on/off, setting a setpoint, setting cooling/heating and setting capacity limitation.
- Beside these four groups there is also a holiday period group which is set the same way as the other groups. Up to 12 holiday periods can be entered in the HD PERIOD screen. During these periods the schedule timer will follow the settings of the holiday period group.

NOTE  A functional diagram showing the schedule timer working can be found in "Annex II" on page 17.

NOTE  The unit always works with "last command". This means that the last command given, whether manually by the user or by the schedule timer, is always executed.

Examples of command that can be given are switching the unit on/off or changing a setpoint.

Activating or deactivating the setpoints password

The SETPOINT PASSWORD screen of the user settings menu allows the user to activate or deactivate the user password needed to change the temperature setpoint. When deactivated, the user does not have to enter the password each time he wants to change the setpoint.



Tasks of the timers menu

Checking the actual value of the software timers

As a protective measure and to ensure correct operation, the controller's software features several countdown timers:

- **LOADUP (LOADUP – refer to the thermostat parameters):** starts counting when a thermostat step change has occurred. During the countdown, the unit is not able to enter a higher thermostat step.
- **LOADDOWN (DOWN – refer to the thermostat parameters):** starts counting when a thermostat step change has occurred. During the countdown, the unit will not be able to enter a lower thermostat step.
- **FLOWSTOP (FLOWSTOP – 5 sec):** starts counting when the water flow through the evaporator stops after the flowstart timer has reached zero. If the water flow has not restarted during the countdown, the unit will shut down.
- **PUMPLEAD (PUMPLEAD – refer to the pump control settings):** starts counting whenever the unit is switched on. During the countdown, the unit cannot start up.
- **PUMPLAG (PUMPLAG – refer to the pump control settings):** starts counting whenever the unit is switched off. During the countdown, the pump keeps running.







To check the actual value of the software timers, proceed as follows:

- 1 Enter the TIMERS MENU through the main menu. (Refer to the chapter "Main menu" on page 9.)
The controller displays the actual value of the GENERAL TIMERS: the loadup timer, the loaddown timer, the flowstart timer, the flowstop timer (when the unit is on and the flowstart timer has reached zero), the pumplead timer and the pumplag timer.
- 2 Press the  key to check the compressor timers (first screen).
The controller shows the actual value of the COMPRESSOR TIMERS: the guard timers (one per compressor) and the antirecycling timers (one per compressor).
- 3 Press the  key to check the compressor timers (second screen).
The controller shows the actual value of the COMPRESSOR TIMERS: the guard timers (one per compressor) and the antirecycling timers (one per compressor).

Tasks of the safeties menu

Listing activated safeties and checking the unit status

If the alarm buzzer is activated and the user presses the  key, the controller automatically enters the safeties menu.

- The controller will enter the UNIT SAFETY screen of the safeties menu when a unit safety was the cause of shutdown. This screen provides the following information:
 - the activated safety: emergency stop, flow switch, sensor error or reverse phase
 - the unit status at the moment of shutdown
 - inlet water temperature setpoint of the evaporator,
 - inlet water temperature setpoint of the condenser,
 - time and date at the moment of shutdown.
 - The controller will enter the MODULE 1, MODULE 2 or MODULE 3 SAFETY screen of the safeties menu when a safety of module 1, respectively module 2 or module 3 was activated. These screens provide information about the module status at the moment of shutdown.
 - the activated safety: freeze-up, general safety or sensor error
 - the unit status at the moment of shutdown
 - inlet water temperature setpoint of the evaporator,
 - inlet water temperature setpoint of the condenser,
 - time and date at the moment of shutdown.
- 1 Press the  key when the alarm buzzer is activated.
The appropriate safety screen with the basic information appears. Press the  key to see the detailed information.
 - 2 If more than one kind of safety is active (indicated by means of ,  or ), use the  and  keys to consult them.

Tasks of the history menu

Checking the safety info and the unit status after a reset

The information available in the safeties menu is also stored in the history menu, where it is stored after resetting the unit or the module. In this way, the history menu provides a means of checking the unit status at the moment of the latest 10 shutdowns.

To check the safety info and the unit status, proceed as follows:

- 1 Enter the HISTORY MENU through the main menu. (Refer to the chapter "Main menu" on page 9.)
The controller enters the UNIT HISTORY screen which contains the following information: the number of shutdowns, the unit safety which caused the most recent shutdown and the basic information at the moment of this shutdown.
- 2 Press the \blacktriangle and \blacktriangledown keys to consult the M1 , M2 or M3 HISTORY screens.
- 3 Press the \blacktriangleleft key to see the detailed information.

Tasks of the info menu

Consulting additional unit information

- 1 Enter the INFO MENU through the main menu. (Refer to the chapter "Main menu" on page 9.)
The controller enters the UNIT INFORMATION screen which contains the following information: the unit name, the refrigerant used and the manufacturing (serial) number.
- 2 Press \blacktriangledown to consult the next UNIT INFORMATION screen.
This screen contains information about the controller's software version.

Tasks of the input/output menu

Checking the status of the inputs and outputs

The input/output menu provides a means of checking the status of the digital inputs and the status of the relay outputs.

The locked digital inputs are:

- M1 , M2 or M3 SAFETY: indicates the status of the general module safeties.
- FLOWSWITCH: indicates the status of the flowswitch, activated or deactivated.
- REVERSE PHASE PROTECTOR: indicates the status of this safety.

The changeable digital inputs are:

- REM. C/H: indicates the status of the remote cooling/heating switch.
- DUAL SETPOINT: indicates the status of the remote dual setpoint switch, setpoint 1 or setpoint 2.
- REM. ON/OFF: indicates the status of the remote on/off switch.
- CAP LIMIT/2/3: indicates the status of the enable/disable capacity limitation switch(es).

The locked relay outputs are:

- LPBYPASS 1/2/3: indicates whether the low pressure of the module is in bypass mode or not.
- C11, C12, C21, C22, C31, C32: indicates whether the compressor is running or not.
- PUMP/GENERATOR: indicates the status of this voltage free contact. It is activated if the pump should be ON, which also indicates general operation.

The changeable relay outputs are:

- REV. VALVE (C/H): indicates whether the unit is running in cooling or in heating.
- 2ND EVAP PUMP: indicates the status of the second evaporator pump.
- CONDENSER PUMP: indicates the status of the condenser pump.
- 100% CAPACITY: indicates when the unit is working at 100%.

To check the inputs and outputs, proceed as follows:

- 1 Enter the I/O STATUS MENU through the main menu. (Refer to the chapter "Main menu" on page 9.)
The controller enters the first DIGITAL INPUTS screen.
- 2 Consult the other screens of the input/output menu using the \blacktriangle and \blacktriangledown keys.

Tasks of the user password menu

Changing the user password

Access to the user settings menu and the setpoints menu is protected by the user password (a 4-digit number between 0000 and 9999).

To change the user password, proceed as follows:

- 1 Enter the USERPASSWORD MENU through the main menu. (Refer to the chapter "Main menu" on page 9.)
The controller will request the password.
- 2 Enter the correct password using the \blacktriangle and \blacktriangledown keys.
- 3 Press \blacktriangleleft to confirm the password and to enter the password menu.
The controller requests the new password.
- 4 Press \blacktriangleleft to start the modification.
The cursor is positioned behind NEW PASSWORD.
- 5 Enter the new password using the \blacktriangle and \blacktriangledown keys.
- 6 Press \blacktriangleleft to confirm the new password.
When the new password has been confirmed, the controller will ask to enter the new password a second time (for safety reasons). The cursor is positioned behind CONFIRM.
- 7 Enter the new password again using the \blacktriangle and \blacktriangledown keys.
- 8 Press \blacktriangleleft to confirm the new password.

NOTE



The actual password will only be changed when the new password and the confirmed password have the same value.

TROUBLESHOOTING

This section provides useful information for diagnosing and correcting certain troubles which may occur in the unit.

Before starting the trouble shooting procedure, carry out a thorough visual inspection of the unit and look for obvious defects such as loose connections or defective wiring.

Before contacting your local dealer, read this chapter carefully, it will save you time and money.



When carrying out an inspection on the supply panel or on the switch box of the unit, always make sure that the circuit breaker of the unit is switched off.

When a safety device was activated, stop the unit and find out why the safety device was activated before resetting it. Under no circumstances safety devices may be bridged or changed to a value other than the factory setting. If the cause of the problem cannot be found, call your local dealer.

Symptom 1: The unit does not start, but the ON LED lights up

POSSIBLE CAUSES	CORRECTIVE ACTION
The temperature setting is not correct.	Check the controller setpoint.
The flowstart timer is still running.	The unit will start after approx. 15 seconds. Make sure that water is flowing through the evaporator.
Neither one of the circuits can start up.	Refer to Symptom 4: One of the circuits does not start up.
Unit is in manual mode (all compressors at 0%).	Check on the controller.
Power supply failure.	Check the voltage on the supply panel.
Blown fuse or interrupted protection device.	Inspect fuses and protection devices. Replace by fuses of the same size and type (refer to "Electrical specifications" on page 2).
Loose connections.	Inspect connections of the field wiring and the internal wiring of the unit. Tighten all loose connections.
Shorted or broken wires.	Test circuits using a tester and repair if necessary.

Symptom 2: The unit does not start, but the ON LED is flashing

POSSIBLE CAUSES	CORRECTIVE ACTION
The remote ON/OFF input is enabled and the remote switch is off.	Put the remote switch on or disable the remote ON/OFF input.

Symptom 3: The unit does not start and the ON LED does not light up

POSSIBLE CAUSES	CORRECTIVE ACTION
All circuits are in failure mode.	Refer to Symptom 5: One of the following safety devices is activated.
One of the following safety devices is activated: <ul style="list-style-type: none"> Flow switch (S8L,S9L) Emergency stop 	Refer to Symptom 5: One of the following safety devices is activated.
The ON LED is broken.	Contact your local dealer.
The unit is in bypass mode.	Check the bypass remote contact.

Symptom 4: One of the circuits does not start up

POSSIBLE CAUSES	CORRECTIVE ACTION
One of the following safety devices is activated: <ul style="list-style-type: none"> Compressor thermal protector (Q*M) Overcurrent relay (K*S) Discharge thermal protector (S*T) Low pressure switch High pressure switch (S*HP) Reverse phase protector (R*P) Freeze-up 	Check on the controller and refer to Symptom 5: One of the following safety devices is activated.
The anti-recycling timer is still active.	The circuit can only start up after approximately 10 minutes.
The guard timer is still active.	The circuit can only start up after approximately 1 minute.
The circuit is limited to 0%.	Check the "enable/disable capacity limitation" remote contact.

Symptom 5: One of the following safety devices is activated

Symptom 5.1: Overcurrent relay of compressor	
POSSIBLE CAUSES	CORRECTIVE ACTION
Failure of one of the phases.	Check fuses on the supply panel or measure the supply voltage.
Voltage too low.	Measure the supply voltage.
Overload of motor.	Reset. If the failure persists, call your local dealer. RESET <i>Push the blue button on the over-current relay inside the switch box and reset the controller.</i>
Symptom 5.2: Low pressure switch	
POSSIBLE CAUSES	CORRECTIVE ACTION
Water flow to water heat exchanger too low.	Increase the water flow.
Shortage of refrigerant.	Check for leaks and refill refrigerant, if necessary.
Unit is working out of its operation range.	Check the operation conditions of the unit.
Inlet temperature to the water heat exchanger is too low.	Increase the inlet water temperature.
Flow switch is not working or no water flow.	Check the flow switch and the water pump. RESET <i>After pressure rise, this safety resets automatically, but the controller still needs to be reset.</i>
Symptom 5.3: High-pressure switch	
POSSIBLE CAUSES	CORRECTIVE ACTION
Water flow to condenser is too low.	Increase the water flow and/or check the strainer for clogging. RESET <i>After finding the cause, push the button on the high-pressure switch housing and reset the controller.</i>
Symptom 5.4: Reverse phase protector is activated	
POSSIBLE CAUSES	CORRECTIVE ACTION
Two phases of the power supply are connected in the wrong phase position.	Invert two phases of the power supply (by licensed electrician).
One phase is not connected properly.	Check the connection of all phases. RESET <i>After inverting two phases or fixing the power supply cables properly, the protector is reset automatically, but the controller still needs to be reset.</i>
Symptom 5.5: Discharge thermal protector is activated	
POSSIBLE CAUSES	CORRECTIVE ACTION
Unit is working outside the operation range.	Check the operation condition of the unit. RESET <i>After temperature decrease, the thermal protector resets automatically but the controller still needs to be reset.</i>

Symptom 5.6: Flow switch is activated	
POSSIBLE CAUSES	CORRECTIVE ACTION
No water flow.	Check the water pump. RESET After finding the cause, the flow switch is reset automatically, but the controller still needs to be reset.
Symptom 5.7: Freeze-up protection is activated	
POSSIBLE CAUSES	CORRECTIVE ACTION
Water flow too low.	Increase the water flow.
Inlet temperature to the evaporator is too low.	Increase the inlet water temperature.
Flow switch is not working or no water flow.	Check the flow switch and the water pump. RESET After temperature increase the freeze-up is reset automatically, but the circuit controller needs to be reset.
Symptom 5.8: Compressor thermal protector is activated	
POSSIBLE CAUSES	CORRECTIVE ACTION
Compressor motor coil temperature too high.	Compressor is not cooled sufficiently by the refrigerant medium. RESET After temperature decrease the thermal protector is reset automatically, but the circuit controller needs to be reset. If the protector is activated frequently, call your local dealer.

Symptom 6: Unit stops soon after operation

POSSIBLE CAUSES	CORRECTIVE ACTION
The schedule timer is activated and is in off mode.	Work according to the settings in the schedule timer or disable the schedule timer.
One of the safety devices is activated.	Check safety devices (refer to Symptom 5: One of the following safety devices is activated).
Voltage is too low.	Test the voltage in the supply panel and, if necessary, in the electrical compartment of the unit (voltage drop due to supply cables is too high).

Symptom 7: Unit runs continuously and the water temperature remains higher than the temperature set on the controller

POSSIBLE CAUSES	CORRECTIVE ACTION
The temperature setting on the controller is too low.	Check and adjust the temperature setting.
The heat production in the water circuit is too high.	The cooling capacity of the unit is too low. Call your local dealer.
Water flow is too high.	Recalculate the water flow.
The circuit is limited.	Check the "enable/disable capacity limitation" remote contact.

Symptom 8: Excessive noises and vibrations of the unit

POSSIBLE CAUSES	CORRECTIVE ACTION
Unit has not been fixed properly.	Fix the unit as described in the installation manual.

MAINTENANCE

In order to ensure optimal availability of the unit, a number of checks and inspections on the unit and the field wiring have to be carried out at regular intervals.

If the unit is used for air conditioning application, the described checks should be executed at least once a year. In case the unit is used for other applications, the checks should be executed every 4 months.



Before carrying out any maintenance or repair activity, always switch off the circuit breaker on the supply panel, remove the fuses or open the protection devices of the unit.

Do never clean the unit with water under pressure.

Important information regarding the refrigerant used

This product contains fluorinated greenhouse gases covered by the Kyoto Protocol.

Refrigerant type: R407C

GWP⁽¹⁾ value: 1652.5

⁽¹⁾ GWP = global warming potential

Periodical inspections for refrigerant leaks may be required depending on European or local legislation. Please contact your local dealer for more information.

Maintenance activities



The wiring and power supply must be checked by a licensed electrician.

- Field wiring and power supply
 - Check the power supply voltage on the local supply panel. The voltage should correspond to the voltage marked on the identification label of the unit.
 - Check the connections and make sure they are properly fixed.
 - Check the proper operation of the circuit breaker and the earth leak detector provided on the local supply panel.
- Internal wiring of the unit

Visually check the switch boxes on loose connections (terminals and components). Make sure that the electrical components are not damaged or loose.
- Earth connection

Make sure that the earth wires are still connected properly and that the earth terminals are tightened.
- Refrigerant circuit
 - Check for leaks inside the unit. In case a leak is detected, call your local dealer.
 - Check the working pressure of the unit. Refer to paragraph "[Switching the unit on](#)" on page 7.
- Compressor
 - Check on oil leaks. If there is an oil leak, call your local dealer.
 - Check for abnormal noises and vibrations. If the compressor is damaged, call your local dealer.
- Water supply
 - Check if the water connection is still well fixed.
 - Check the water quality (refer to the installation manual of the unit for specifications of the water quality).
- Water filters
 - Check if the mesh width is 1 mm maximum.

Disposal requirements

Dismantling of the unit, treatment of the refrigerant, oil and any other parts, should be done in accordance with the relevant local and national regulations.

ANNEX I

Thermostat parameters

Cooling: Inlet water temperature control of evaporator

Heating: Inlet water temperature control of condenser

The figures below show the thermostat diagram in case of inlet water temperature control.

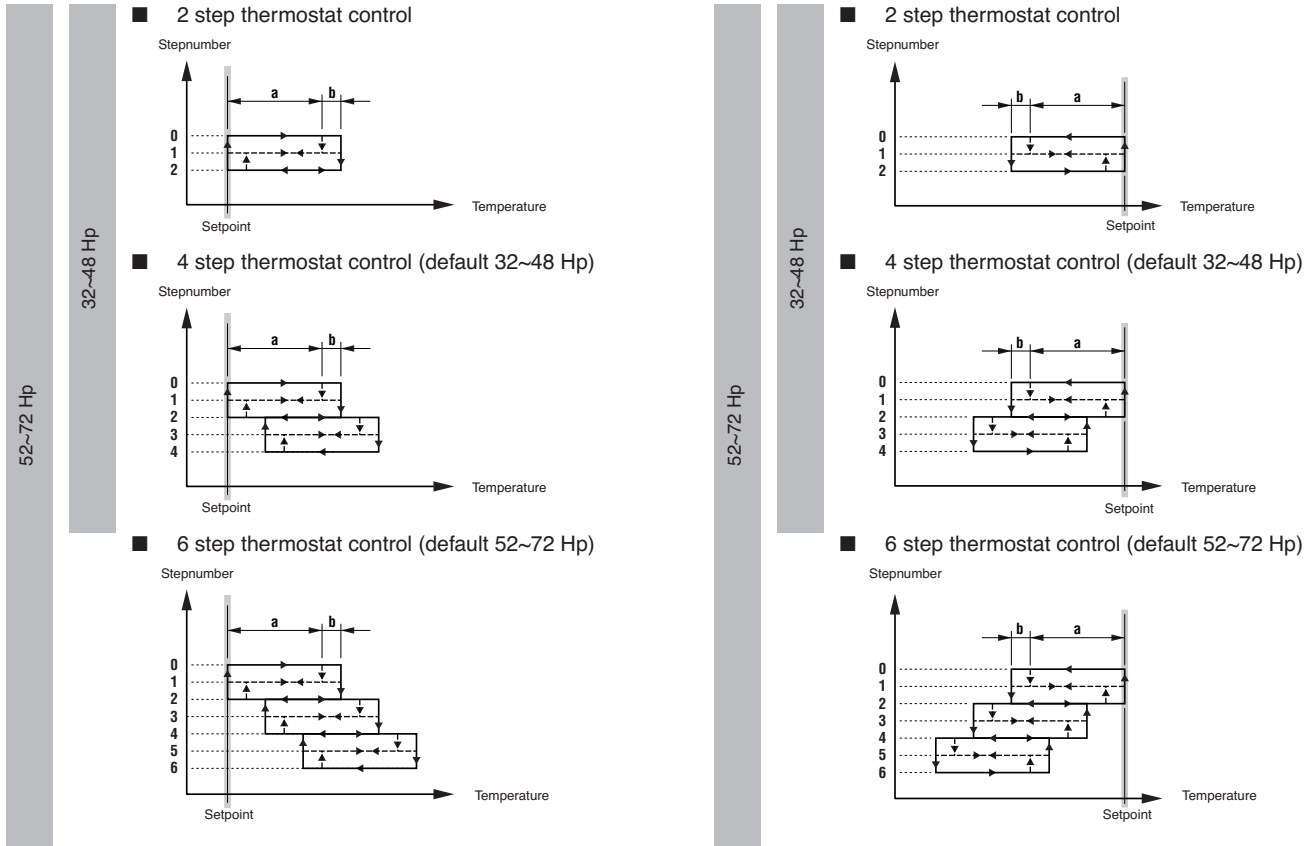

The default value and the upper and lower limits of the thermostat parameters are listed in the table below.

INLET CONTROL		Default value	Lower limit	Upper limit
Steplength - a	(K)	1.5	0.4	2.0
Step difference - b	(K)	0.5	0.2	0.8
Load-up time	(sec)	180	15	300
Load-down time	(sec)	20	15	300
Setpoint Cooling	(°C)	12.0	8.0	23.0
Setpoint Heating	(°C)	30.0	15.0	50.0

NOTE The thermostat parameters mentioned above only apply to standard units.



ANNEX II

Schedule timer example

MARCH						
MON	TUE	WED	THU	FRI	SAT	SUN
1 G1	2 G1	3 G2	4 G1	5 G1	6 G3	7 G3
8 G1	9 G1	10 G2	11 G1	12 G1	13 G3	14 G3
15 G1	16 G1	17 G2	18 G1	19 G1	20 G3	21 G3
22 G1	23 H	24 H	25 H	26 H	27 H	28 H
29 H	30 G1	31 G2				

To come to the schedule above following settings have to be made:

```

┌──┐ SCHEDULE TIMER
│MON:G1 THU:G1 SAT:G3
│TUE:G1 FRI:G1 SUN:G3
│WED:G2
└──┘

```

⋮

```

┌──┐ HD PERIOD: 01 TO 03
│01:23/03 TO 29/03
│02:00/00 TO 00/00
│03:00/00 TO 00/00
└──┘

```

All days assigned to the same group will work according to the settings of this group.

In this example setting:

- all Mondays, Tuesdays, Thursdays and Fridays will work according to the settings in group 1 (G1),
- all Wednesdays will work according to the settings in group 2 (G2),
- all Saturdays and Sundays will work according to the group 3 (G3),
- all holiday days will work according to the settings in the holiday group (H).

All group settings of groups G1, G2, G3, G4 and H work similar as following example (settings for group 1):

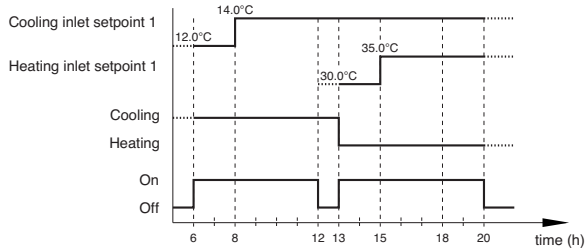

```

┌──┐ GROUP1: 01 TO 03
│1:06:00 ISP1 E: 12.0
│2:06:00 ON COOL
│3:08:00 ISP1 E: 14.0
└──┘

```

Screen 1

⋮

```

┌──┐ GROUP1: 04 TO 06
│4:12:00 OFF
│5:13:00 ISP1 C: 30.0
│6:13:00 ON HEAT
└──┘

```

Screen 2

⋮

```

┌──┐ GROUP1: 07 TO 09
│7:15:00 ISP1 C: 35.0
│8:20:00 OFF
│9:00:00 - -
└──┘

```

Screen 3

ANNEX III - SOFTWARE STRUCTURE

Actual screens can be different than the shown example (52~72 Hp).

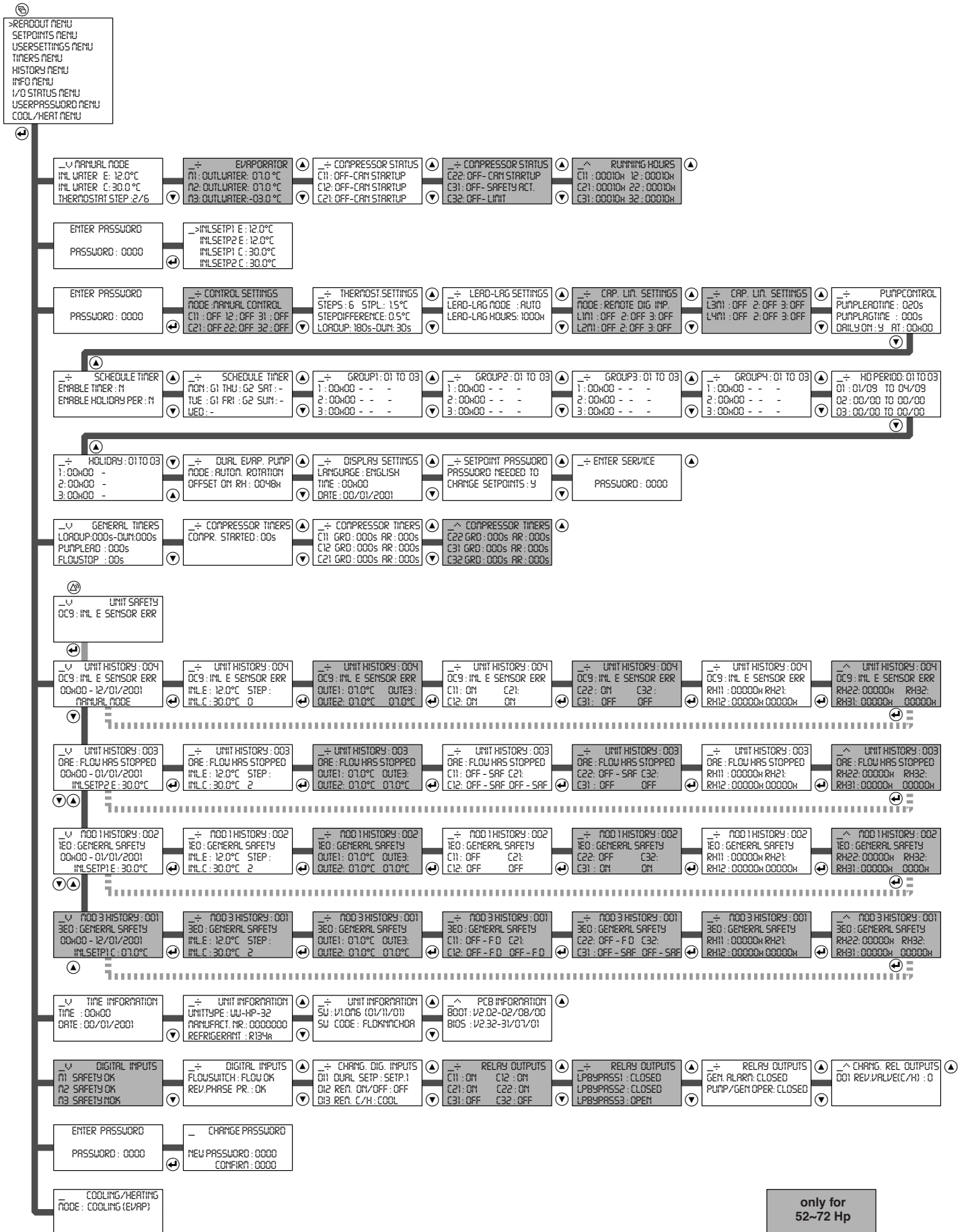



4PW61664-1 A 0000000P

Copyright 2010 Daikin

DAIKIN EUROPE N.V.

Zandvoordestraat 300, B-8400 Oostende, Belgium

4PW61664-1A 2012.04