Wireless Remote Controller Kit

MODELS:**BRC7CB58****BRC7CB59**

Thank you for purchasing this product.
Carefully read this operation manual to ensure proper operation.
After reading the manual, file it away for future reference.
Furthermore, make certain that this operation manual is handed to a new user when he takes over the operation.

Vielen Dank für den Kauf einer Klimaanlage von Daikin.
Bitte lesen Sie diese Bedienungsanleitung vor der Inbetriebnahme des Gerätes gründlich durch.
Hier wird erklärt, wie das Gerät richtig eingesetzt wird und was bei Störungen zu tun ist.
In dieser Anleitung wird nur das Innenaggregat beschrieben.
Verwenden Sie diese Anleitung zusammen mit der Bedienungsanleitung des Außenaggregats.
Nach dem Lesen der Anleitung legen Sie diese griffbereit zum Nachschlagen auf.

Nous vous remercions pour votre acquisition de ce climatiseur Daikin.
Lisez attentivement ce manuel avant d'utiliser le climatiseur.
Il vous expliquera comment vous servir correctement de l'appareil et vous guidera en cas de problème.
Lorsque vous aurez lu le manuel, rangez-le afin de pouvoir vous y référer ultérieurement.

Le agradecemos la compra de este acondicionador de aire Daikin.
Lea cuidadosamente el manual de funcionamiento antes de utilizar el acondicionador de aire.
Dicho manual le indicará cómo utilizar adecuadamente la máquina y le ayudará en caso de avería.
Después de leer el manual, consérvelo para consultas futuras.

La ringraziamo di aver acquistato questo condizionatore d'aria Daikin.
Leggere attentamente questo manuale prima di avviare il condizionatore.
Ciò permetterà di usare correttamente l'unità e di ottenere un aiuto in caso di anomalia di funzionamento.
Dopo aver letto il manuale, conservarlo in un luogo accessibile per una futura necessità.

Σας ευχαριστούμε που αγοράσατε τη συσκευή κλιματισμού.
Διαβάστε προσεκτικά αυτές τις οδηγίες χρήσης πριν να χρησιμοποιήσετε τη συσκευή κλιματισμού.
Θα σας πουν πως θα χρησιμοποιήσετε σωστά τη μονάδα και θα σας βοηθήσουν αν εμφανιστούν προβλήματα.
Αφού διαβάσετε τις οδηγίες, Βάλτε τις στο αρχείο σας για μελλοντική αναφορά.

English

Deutsch

Français

Español

Italiano

Ελληνικά

Nederlands

Portugues

Русский

Türkçe

Wij danken u voor de aankoop van deze Daikin airconditioner.

Lees deze bedrijfshandleiding aandachtig door voordat u de airconditioner gebruikt.

Het omvat uitleg over het correcte gebruik van de unit en biedt hulp in geval een storing mocht optreden.

Gebruik deze handleiding voor verdere raadpleging.

Obrigado pela sua compra deste aparelho de ar condicionado Daikin.

Leia com atenção este manual de operação antes de proceder à utilização do aparelho de ar condicionado.

Este indicar-lhe-á como deverá utilizar a unidade correctamente e ajudá-lo-á no caso de surgir qualquer problema.

Depois de ler o manual, guarde-o num local seguro a fim de o poder consultar caso venha a ser preciso.

Спасибо за покупку данного кондиционера фирмы Daikin.

До начала работы с кондиционером внимательно изучите данное руководство по эксплуатации.

В нем излагаются правила надлежащего пользования устройством и приводятся рекомендации пользователю по поиску и устранению неисправностей.

После изучения руководства сохраните его для обращений в будущем.

Daikin klima satın aldığınız için teşekkür ederiz.

Klimanızı kullanmadan önce bu kullanma kılavuzunu dikkatlice okuyunuz. Bu kılavuz ünitenin nasıl uygun olarak kullanılacağını anlatır ve herhangi bir problem olduğunda size yardım eder. Bu kılavuzda yalnızca iç ünite ile ilgili bilgiler verilmektedir. Bu dökümanı dış ünite ile ilgili kullanım kılavuzu ile birlikte kullanınız. Kullanma kılavuzunu okuduktan sonra ilerde tekrar faydalanmak üzere saklayınız.

Fig. 1-1

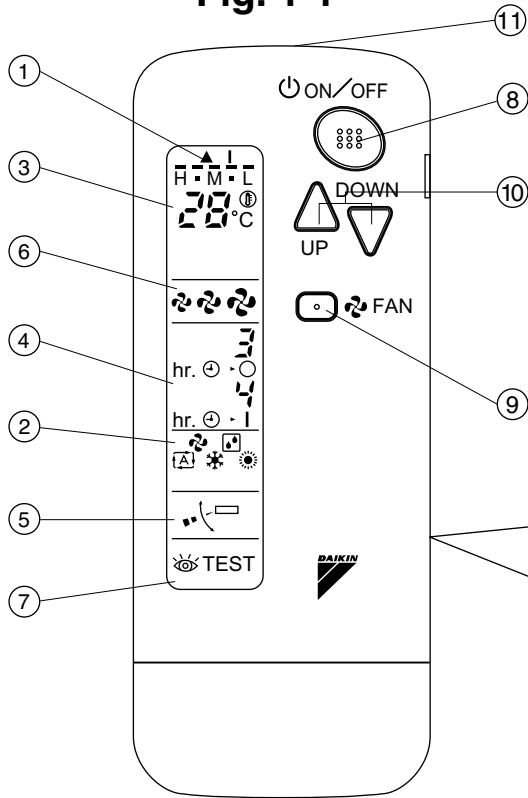

Fig. 1-2

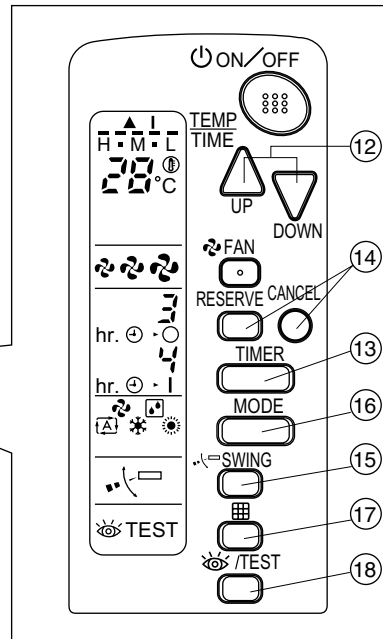

Fig. 2-1

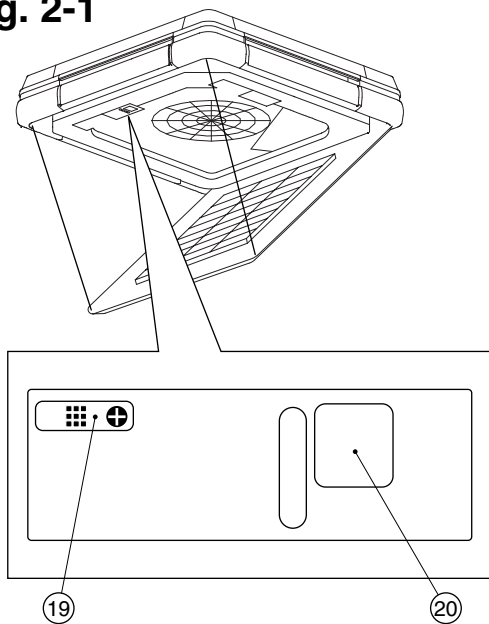
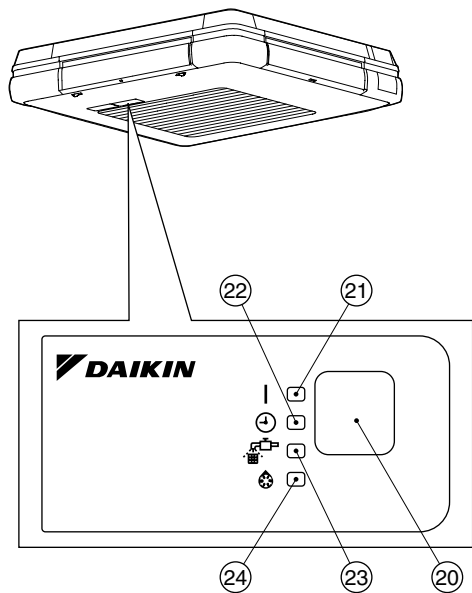

Fig. 2-2



PRIOR TO USE

This operation manual is exclusively for instructions on how to use the wireless remote controller. Read also the operation manual attached to the indoor unit and to the outdoor unit for safe usage of the system and maintenance.

VOR DER INBETRIEBNAHME

Diese Betriebsanleitung enthält ausschließlich Anweisungen über den Gebrauch der drahtlosen Fernbedienung. Über die sichere Anwendung und Wartung des Systems, lesen Sie auch die dem Innenaggregat beiliegende Bedienungsanleitung.

AVANT LA MISE EN SERVICE

Ce mode d'emploi ne concerne que les instructions d'utilisation de la télécommande sans câble. Lire également le mode d'emploi joint à l'unité intérieure pour une utilisation et un entretien du système en toute sécurité.

ANTES DE LA UTILIZACIÓN

Este manual de instrucciones contiene sólo las instrucciones para el uso del control remoto sin cables. Lea también el manual de instrucciones que viene con la unidad interior para un uso seguro del sistema y para su mantenimiento.

PRIMA DELL'USO

Il presente manuale d'uso fornisce esclusivamente istruzioni per l'uso del telecomando via radio. Per un uso sicuro del sistema e per la sua manutenzione leggere inoltre il manuale d'uso in dotazione all'unità interna.

ΠΡΙΝ ΑΠΟ ΤΗ ΧΡΗΣΗ

Αυτό το εγχειρίδιο λειτουργίας περιέχει μόνο οδηγίες για τη χρήση του ασύρματου τηλεχειριστηρίου. Διαβάστε επίσης το εγχειρίδιο λειτουργίας που συνοδεύει την εσωτερική μονάδα για την ασφαλή χρήση του συστήματος και για τη συντήρηση.

VOOR GEBRUIK

Deze bedieningshandleiding is uitsluitend bedoeld voor gebruik tijdens de instructie over de werking van de afstandsbediening.

Lees ook de bedieningshandleiding die werd meegeleverd bij de binnenunit voor een veilig gebruik van het systeem en het onderhoud ervan.

ANTES DE UTILIZAR

O presente manual de funcionamento destina-se exclusivamente para explicar o modo de utilização do controlo remoto sem fio.

Leia igualmente o manual de funcionamento fornecido com a unidade interior para uma utilização e manutenção segura do sistema.

ПОДГОТОВКА К ИСПОЛЬЗОВАНИЮ

Данное руководство по эксплуатации посвящено исключительно инструктированию работе с беспроводным удаленным контроллером.

Для безопасного использования и технического обслуживания системы ознакомьтесь также с руководством по эксплуатации, прилагаемом к комнатному блоку.

KULLANMADAN ÖNCE

Bu kullanım kılavuzu yalnızca kablosuz uzaktan kumandanın kullanımına ilişkin talimatları içermektedir. Sistemin güvenli kullanımı ve bakımı için iç ünite ve dış ünite ile birlikte gelen kullanım kılavuzunu da okuyunuz.



■ Disposal requirements

Your product and the batteries supplied with the controller are marked with this symbol. This symbol means that electrical and electronic products and batteries shall not be mixed with unsorted household waste.

For batteries, a chemical symbol can be printed beneath the symbol. This chemical symbol means that the battery contains a heavy metal above a certain concentration. Possible chemical symbols are:

■ Pb: lead (>0,004%)

Do not try to dismantle the system yourself: the dismantling of the product, treatment of the refrigerant, of oil and of other parts must be done by a qualified installer in accordance with relevant local and national legislation.

Units and waste batteries must be treated at a specialized treatment facility for re-use, recycling and recovery.

By ensuring correct disposal, you will help to prevent potential negative consequences for the environment and human health.

Please contact the installer or local authority for more information.

■ Vorschriften zur Entsorgung

Ihr Produkt und die mit dem Controller mitgelieferten Batterien tragen dieses Symbol. Das Symbol weist darauf hin, dass elektrische und elektronische Produkte und Batterien nicht zusammen mit unsortiertem Hausmüll beseitigt werden dürfen.

Bei Batterien kann unter dem Symbol ein anderes für eine chemische Substanz aufgedruckt sein. Dieses Symbol bedeutet dann, dass die Batterie ein Schwermetall enthält in einer Konzentration, die über einem bestimmten Grenzwert liegt. Mögliche Symbole für Chemikalien:

■ Pb: Blei (>0,004%)

Versuchen Sie auf keinen Fall, das System selber auseinanderzunehmen. Das Auseinandernehmen des Produkts sowie die Handhabung von Kältemitteln, Öl und weiteren Teilen muss von einem qualifizierten Monteur in Übereinstimmung mit den relevanten örtlichen und staatlichen Vorschriften erfolgen.

Die zu entsorgenden Einheiten und Batterien müssen zwecks ordnungsgemäßer Behandlung einem Betrieb zugeführt werden, der auf Wiederverwendung, Recycling und Wiederverwertung spezialisiert ist.

Indem Sie das Produkt einer korrekten Entsorgung zuführen, tragen Sie dazu bei, dass für die Umwelt und für die Gesundheit von Menschen keine negativen Auswirkungen entstehen. Für weitere Informationen wenden Sie sich bitte an die Installationsfirma oder an die zuständige örtliche Behörde.

■ Instructions d'élimination

Votre produit et les piles fournies avec le contrôleur sont marqués du symbole suivant. Ce symbole signifie que les appareils électriques et électroniques et les piles doivent être éliminés séparément des ordures ménagères non triées.

En ce qui concerne les piles, un symbole chimique peut être imprimé sous le symbole. Ce symbole chimique signifie que la pile contient un métal lourd au-delà d'une certaine concentration. Symboles chimiques possibles:

■ Pb: plomb (>0,004%)

Ne pas essayer de démonter vous-même l'appareil: le démontage du produit ainsi que le traitement du réfrigérant, de l'huile et d'autres composants doivent être effectués par un installateur qualifié, en accord avec les réglementations locales et nationales en vigueur. Les unités et piles jetables doivent être apportées à des installations spécialisées dans le réemploi, le recyclage ou le retraitement.

Au travers d'une mise au rebut correcte, vous contribuez à éviter les conséquences potentiellement néfastes sur l'environnement et la santé. Veuillez contacter votre installateur ou les autorités locales pour plus d'information.

■ Requisitos para la eliminación

Su producto y las pilas suministrados con el control vienen marcados con este símbolo. Este símbolo significa que los productos eléctricos y electrónicos y las pilas no deben mezclarse con el resto de residuos domésticos no clasificados.

En el caso de las pilas puede aparecer un símbolo impreso bajo el símbolo, esto significa que las pilas presentan un metal pesado que se encuentra por encima de una determinada concentración. Estos son los posibles símbolos químicos:

■ Pb: plomo (>0,004%)

No intente desmontar el sistema usted mismo: El desmantelamiento del producto, así como el tratamiento del refrigerante, aceite y otros componentes, debe ser efectuado por un instalador competente de acuerdo con las normas locales y nacionales aplicables. Las unidades y pilas agotadas deben ser tratadas en instalaciones especializadas para su reutilización, reciclaje y recuperación.

Al asegurarse de desechar este producto de la forma correcta, está contribuyendo a evitar posibles consecuencias negativas para el entorno y para la salud de las personas. Contacte, por favor, con el instalador o con las autoridades locales para obtener más información.

■ Istruzioni per lo smaltimento

Il prodotto e le batterie in dotazione con l'unità di comando sono contrassegnati con questo simbolo. Questo simbolo sta ad indicare che i prodotti elettrici ed elettronici, così come le batterie, non possono essere smaltiti insieme ai rifiuti domestici indifferenziati.

Sulle batterie, sotto al simbolo è possibile trovare stampato un simbolo chimico. Questo simbolo chimico indica che la batteria contiene un metallo pesante al di sopra di una certa concentrazione. I simboli chimici possibili sono:

■ Pb: piombo (>0,004%)

Non cercare di smontare il sistema da soli: lo smontaggio del prodotto, nonché il recupero del refrigerante, dell'olio e di qualsiasi altra parte, devono essere eseguiti da un installatore qualificato in conformità con le relative norme locali e nazionali in vigore.

Le unità e le batterie usate devono essere trattate presso una struttura specializzata nel riutilizzo, riciclaggio e recupero dei materiali.

Il corretto smaltimento del prodotto eviterà possibili conseguenze negative per l'ambiente e la salute dell'uomo.

Per maggiori informazioni contattare l'installatore o le autorità locali.

■ Προϋποθέσεις απόρριψης

Το συγκεκριμένο προϊόν καθώς οι μπαταρίες που παρέχονται με το χειριστήριο επισημαίνονται με αυτό το σύμβολο. Αυτό σημαίνει ότι τα ηλεκτρικά και ηλεκτρονικά προϊόντα, καθώς και οι μπαταρίες πρέπει να απορρίπτονται χωριστά από τα οικιακά απορρίμματα.

Στις μπαταρίες, κάτω από αυτό το σύμβολο μπορεί να αναγράφεται ένα χημικό σύμβολο. Αυτό το χημικό σύμβολο σημαίνει ότι η μπαταρία περιέχει ένα βαρύ μέταλλο σε μεγαλύτερη συγκέντρωση από μία ορισμένη τιμή. Πιθανά χημικά σύμβολα είναι:

■ Pb: μόλυβδος (>0,004%)

Μην προσπαθήσετε να αποσυρμαολογήσετε μόνοι σας το σύστημα: Η αποσυρμαολογήση του προϊόντος, ο χειρισμός του ψυκτικού, του λαδιού και των άλλων τμημάτων θα πρέπει να γίνεται από κάποιο εξειδικευμένο τεχνικό, σύμφωνα με τη σχετική τοπική και εθνική νομοθεσία. Οι μονάδες και οι άδειες μπαταρίες θα πρέπει να υφίστανται μία ειδική επεξεργασία για την επανάχρηση, την ανακύκλωση και την αποκατάστασή τους.

Φροντίζοντας για τη σωστή απόρριψη του προϊόντος, θα αποφύγετε ενδεχόμενες αρνητικές συνέπειες για το περιβάλλον και την υγεία.

Παρακαλώ επικοινωνήστε με τον τεχνικό εγκατάστασης ή τις τοπικές αρχές για περισσότερες πληροφορίες.

■ Vereisten voor het opruimen

Uw product en de bij de controller geleverde batterijen dragen dit symbool. Dit symbool betekent dat u geen elektrische en elektronische producten en batterijen mag mengen met niet-gesorteerd huishoudelijk afval.

Voor batterijen kan een chemisch symbool onder het symbool staan. Dit chemisch symbool geeft aan dat de batterij meer dan een bepaalde concentratie van een zwaar metaal bevat. Mogelijke chemische symbolen:

■ Pb: lood (>0,004%)

Probeer het systeem niet zelf te ontmantelen: het ontmantelen van het product, het behandelen van het koelmiddel, van olie en van andere onderdelen moeten gebeuren door een bevoegd monteur in overeenstemming met de relevante lokale en nationale reglementeringen.

Units en afvalbatterijen moeten bij een gespecialiseerd behandelingsbedrijf worden behandeld voor hergebruik, recyclage en terugwinning.

Door ervoor te zorgen dat op de correcte manier wordt opgeruimd, helpt u potentiële negatieve gevolgen voor het milieu en de gezondheid te voorkomen.

Voor meer informatie, gelieve contact op te nemen met de monteur of de lokale overheid.

■ Requisitos para a eliminação

O produto e as pilhas fornecidas com o controlo encontram-se assinalados com este símbolo. O símbolo indica que produtos eléctricos e electrónicos, incluindo pilhas, não devem ser misturados com o lixo doméstico indiferenciado.

No caso das pilhas, é possível que um símbolo de produto químico esteja presente sob este. O símbolo de produto químico indica que a pilha contém um metal pesado numa concentração superior a um determinado limite. Possíveis símbolos de produtos químicos:

■ Pb: chumbo (>0,004%)

Não tente desmontar pessoalmente o sistema: a desmontagem do produto e o tratamento do refrigerante, do óleo e de outros componentes têm de ser efectuados por um instalador qualificado, cumprindo a legislação nacional relevante e regulamentos locais aplicáveis. As unidades e as pilhas gastas têm de ser processadas numa estação de tratamento especializada, para reutilização, reciclagem e/ou recuperação.

Ao efectuar uma eliminação correcta, ajuda a evitar as potenciais consequências negativas para o ambiente e para as condições de saúde.

Contacte o seu instalador ou as autoridades locais, para obter mais informações.

■ Утилизация отходов

Ваше изделие и батарейки, входящие в комплектацию пульта, помечены этим символом. Этот символ означает, что электрические и электронные изделия, а также батарейки, не следует смешивать с несортированным бытовым мусором. На батарейках под указанным символом иногда отпечатан химический знак, который означает, что в батарейках содержится тяжелый металл выше определенной концентрации. Встречающиеся химические знаки:

■ Pb: свинец (>0,004%)

Не пытайтесь демонтировать систему самостоятельно: демонтаж изделия, удаление холодильного агента, масла и других частей должны проводиться квалифицированным специалистом в соответствии с местным и общегосударственным законодательством.

Агрегаты и отработанные батарейки необходимо сдавать на специальную перерабатывающую станцию для утилизации, переработки и вторичного использования.

Обеспечивая надлежащую утилизацию, вы способствуете предотвращению отрицательных последствий для окружающей среды и здоровья людей.

За более подробной информацией обращайтесь к монтажнику или в местные компетентные органы.

■ Bertaraf gereksinimleri

Ürününüz ve kumanda ile birlikte verilen piller üzerinde bu sembol vardır. Bu sembolün anlamı, elektrikli ve elektronik ürünlerle piller ayrılmamış evsel atıklarla karıştırılmayacak demektir.

Piller için, sembolün altında kimyasal bir sembol de yazılı olabilir. Bu kimyasal sembolün anlamı, pil belirli bir konsantrasyonun üzerinde ağır metal içeriyor demektir. Olası kimyasal semboller şunlardır:

■ Pb: kurşun (> 0,004%)

Sistemi kendi kendinize demonte etmeye çalışmayın: ürünün demonte edilmesi ve soğutucu, yağ ve diğer parçalarını ilgili işlemler yerel ve ulusal mevzuata uygun olarak bir montaj görevlisi tarafından gerçekleştirilmelidir.

Üniteler ve kullanılmış piller yeniden kullanım, geri dönüşüm ve kazanım için özel bir işleme tesisinde işlenmelidir.

Doğru atık işlemini sağlayarak, çevre ve insan sağlığına olası olumsuz etkilerin önlenmesine katkı sağlamış olacaksınız.

Lütfen daha fazla bilgi için montaj görevlisi veya yerel yetkili ile irtibat kurun.

CONTENTS

ILLUSTRATIONS.....	[1]
PRIOR TO USE.....	[2]
1. SAFETY PRECAUTIONS.....	1
2. WHAT TO DO BEFORE OPERATION.....	4
3. NAMES AND FUNCTIONS OF THE OPERATING SECTION.....	4
4. HANDLING FOR WIRELESS REMOTE CONTROLLER.....	5
5. OPERATION RANGE.....	6
6. INSTALLATION SITE.....	6
7. OPERATION PROCEDURE.....	6
8. OPERATION CHARACTERISTICS.....	11
9. OPTIMUM OPERATION.....	11
10. MAINTENANCE (FOR SERVICE PERSONNEL).....	11
11. NOT MALFUNCTION OF THE AIR CONDITIONER.....	11
12. HOW TO DIAGNOSE TROUBLE SPOTS....	11

The original instructions are written in English. All other languages are translations of the original instructions.

1. SAFETY PRECAUTIONS

To gain full advantage of the air conditioner's functions and to avoid malfunction due to mishandling, please read this operation manual carefully before use.

This product comes under the term "appliances not accessible to the general public".

- **This manual classifies the precautions into WARNINGS and CAUTIONS. Be sure to follow all the precautions below: They are all important for ensuring safety.**

 **WARNING** Indicates a potentially hazardous situation which, if not avoided, could result in death or serious injury.

 **CAUTION** Indicates a potentially hazardous situation which, if not avoided, may result in minor or moderate injury.
It may also be used to alert against unsafe practices.

- **After reading, keep this manual in a convenient place so that you can refer to it whenever necessary. If the equipment is transferred to a new user, be sure also to hand over the manual.**

WARNING

Be aware that prolonged, direct exposure to cool or warm air from the air conditioner, or to air that is too cool or too warm can be harmful to your physical condition and health.

When the air conditioner is malfunctioning (giving off a burning odor, etc.), turn off the power to the air conditioner and contact your local dealer.

Continued operation under such circumstances may result in a failure, electric shocks or a fire.

Consult your local dealer about installation work.

Doing the work yourself may result in water leakage, electric shocks or a fire.

Consult your local dealer regarding modification, repair and maintenance of the air conditioner.

Improper workmanship may result in water leakage, electric shocks or a fire.

Do not place objects, including rods, your fingers, etc., in the air inlet or outlet.

Injury may result due to contact with the air conditioner's highspeed fan blades.

Beware of a fire in case of refrigerant leakage.

If the air conditioner is not operating correctly, i.e. not generating cool or warm air, refrigerant leakage could be the cause. Consult your local dealer for assistance. The refrigerant used for the air conditioner is safe and normally does not leak. However, if the refrigerant leaks and gets in contact with a naked burner, heater or cooker, it may generate hazardous compounds. Turn off the air conditioner and call your local dealer.

Turn on the air conditioner after the qualified service person makes sure to confirm that the leakage is repaired.

Consult your local dealer regarding what to do in case of refrigerant leakage.

When the indoor unit is installed in a small room, it is necessary to take proper measures so that the amount of any leaked refrigerant does not exceed the concentration limit in the event of a leakage. Otherwise, this may lead to an accident due to oxygen depletion.

Contact professional personnel about attachment of accessories and be sure to use only accessories specified by the manufacturer.

If a defect results from your own workmanship, it may result in water leakage, electric shocks or a fire.

Consult your local dealer regarding relocation and reinstallation of the air conditioner. Improper installation work may result in leakage, electric shocks or a fire.

Be sure to use fuses with the correct ampere reading.

Do not use improper fuses, copper or other wires as a substitute, as this may result in electric shocks, a fire, injury or damage to the air conditioner.

Be sure to earth the air conditioner.

Do not earth the air conditioner to a utility pipe, lightning conductor or telephone earth lead. Imperfect earthing may result in electric shocks or a fire.

A high surge current from lightning or other sources may cause damage to the air conditioner.

Be sure to install an earth leakage breaker.

Failure to install an earth leakage breaker may result in electric shocks or a fire.

Consult your local dealer if the air conditioner submerges owing to a natural disaster, such as a flood or typhoon.

Do not operate the air conditioner in that case, or otherwise a malfunction, electric shocks, or a fire may result.

Start or stop the air conditioner with the remote controller. Never use the power circuit breaker for this purpose.

Otherwise, it may cause a fire or water leakage. Furthermore, if an automatic restart control is provided against power failure and the power is recovered, the fan will rotate suddenly and may cause injury.

Do not use the air conditioner in the atmosphere contaminated with oil vapor, such as cooking oil or machine oil vapor.

Oil vapor may cause crack damage to the air conditioner, electric shocks, or a fire.

Do not use the air conditioner in places with excessive oily smoke, such as cooking rooms, or in places with flammable gas, corrosive gas, or metal dust.

Using the air conditioner in such places may cause a fire or air conditioner failures.

Do not use flammable materials (e.g., hair-spray or insecticide) near the air conditioner. Do not clean the air conditioner with organic solvents such as paint thinner.

The use of organic solvents may cause crack damage to the air conditioner, electric shocks, or a fire.

Be sure to use a dedicated power supply for the air conditioner.

The use of any other power supply may cause heat generation, a fire, or air conditioner failures.

Consult your local dealer regarding cleaning the inside of the air conditioner.

Improper cleaning may cause breakage of plastic parts, water leakage and other damage as well as electric shocks.

 **CAUTION**

Do not use the air conditioner for purposes other than those for which it is intended.

Do not use the air conditioner for cooling precision instruments, food, plants, animals or works of art as this may adversely affect the performance, quality and/or longevity of the object concerned.

Do not remove the outdoor unit's outlet side grille.

The grille protects against the unit's high speed fan, which may cause injury.

To avoid oxygen deficiency, ensure that the room is adequately ventilated if equipment such as a burner is used together with the air conditioner.

Do not place flammable sprays or operate spray containers near the air conditioner as this may result in a fire.

Do not put flammable containers, such as spray cans, within 1 m from the air outlet.

The containers may explode because the warm air from the indoor or outdoor unit will affect them.

Before cleaning, be sure to stop the air conditioner operation, turn the power circuit breaker off.

Otherwise, an electric shocks and injury may result.

To avoid electric shocks, do not operate with wet hands.

Do not place objects that are susceptible to moisture directly beneath the indoor or outdoor units.

Under certain conditions, condensation on the unit or refrigerant piping, air filter dirt or drain blockage may cause dripping, resulting in fouling or failure of the object concerned.

Do not place appliances that produce naked flames in places exposed to the airflow from the air conditioner as this may impair combustion of the burner.

Do not place heaters directly below the indoor unit, as resulting heat can cause deformation.

Do not allow a child to mount on the outdoor unit or avoid placing any object on it.

Falling or tumbling may result in injury.

Be sure that children, plants or animals are not exposed directly to airflow from the indoor unit, as adverse effects may ensue.

Do not wash the air conditioner with water, as this may result in electric shocks or a fire.

Do not place water containers (flower vases, etc.) on the indoor unit, as this may result in electric shocks or a fire.

Do not install the air conditioner at any place where there is a danger of flammable gas leakage.

In the event of a gas leakage, build-up of gas near the air conditioner may result in a fire.

Carry out drain piping properly to ensure complete drainage.

If drain piping is not carried out properly, drain will not flow out. Then, dirt and debris may be accumulated in the drain pipe and may cause water leakage. If it occurs, stop the air conditioner and call your local dealer for assistance.

The appliance is not intended for use by unattended young children or persons who are incompetent to operate air conditioners. It may result in injury or electric shocks.

Children should be watched so that they do not play with the indoor unit or its remote controller. Accidental operation by a child may result in injury or electric shocks.

To avoid injury, do not touch the air inlet or aluminum fins of the air conditioner.

Do not place objects in direct proximity of the outdoor unit and do not let leaves and other debris accumulate around the unit.

Leaves are a hotbed for small animals which can enter the unit. Once in the unit, such animals can cause malfunctions, smoke or a fire when making contact with electrical parts.

Do not block air inlets nor outlets.

Impaired airflow may result in insufficient performance or trouble.

Do not let children play on or around the outdoor unit.

If they touch the unit carelessly, injury may be caused.

Turn off the power when the air conditioner is not used for long periods of time.

Otherwise, the air conditioner may get hot or catch on a fire due to dust accumulation.

Never touch the internal parts of the remote controller.

Do not remove the front panel. Touching certain internal parts will cause electric shocks and damage to the remote controller. Please consult your local dealer about checking and adjustment of internal parts.

Do not leave the remote controller wherever there is a risk of wetting.

If water gets into the remote controller there is a risk of electrical leakage and damage to electronic components.

Watch your steps at the time of air filter cleaning or inspection.

High-place work is required, to which utmost attention must be paid.

If the scaffold is unstable, you may fall or topple down, thus causing injury.

When using the wireless remote controller, do not put a strong light beam or install an inverter fluorescent lamp near the receiving section on the indoor unit.

The batteries must be removed from the appliance before it is scrapped and they are disposed of safely.

• NOTE TO SERVICE PERSONNEL

— ⚠ WARNING —

⚠ RISK OF ELECTRIC SHOCKS OR A FIRE

- When checking the electric components (such as the inside of the control box, fan motor, drain pump, etc.), make sure to shut off all power supply for the air conditioner (including both indoor and outdoor units).
- When cleaning the heat exchanger, make sure to remove the electronic components above. (If they get cleaning agent, there is a risk that the components will burn out because of insulation degradation.)

⚠ CAUTION! DANGER OF ELECTRIC SHOCKS

- Shut off power supply before work.
- Never open the control box lid for 10 minutes after shutting off the power supply because there is residual voltage.
- After opening the control box lid, measure residual voltage between the points shown Fig. 3 on the Printed Circuit Board by the tester without touching the live part and confirm that the residual voltage is DC50V or below.

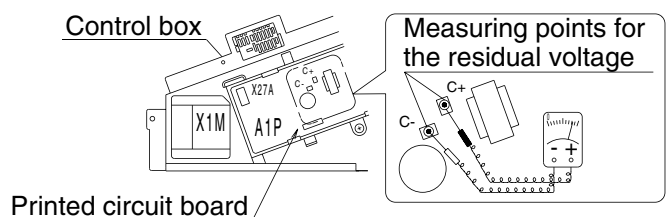







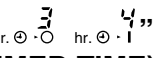





Fig. 3





- After power failure, operation will restart automatically.

2. WHAT TO DO BEFORE OPERATION

Refer to the operation manual attached to the indoor unit.

3. NAMES AND FUNCTIONS OF THE OPERATING SECTION (Refer to Fig. 1-1, 1-2, 2-1, 2-2 on page [1])

1	DISPLAY “▲” (SIGNAL TRANSMISSION)
	This lights up when a signal is being transmitted.
2	DISPLAY “” “” “” “” “” (AUTOMATIC) and “” (HEATING) are not installed.
	3
This display shows the set temperature.	
4	DISPLAY “” (PROGRAMMED TIME)
	This display shows PROGRAMMED TIME of the air conditioner start or stop.
5	DISPLAY “” (HORIZONTAL BLADE)
	Refer to page 8.
6	DISPLAY “” “” “” (FAN SPEED)
	The display shows the set fan speed.
7	DISPLAY “ TEST” (INSPECTION/ TEST OPERATION)
	When the INSPECTION/TEST OPERATION BUTTON is pressed, the display shows the system mode is in. Do not operate this button during normal use.
8	ON/OFF BUTTON
	Press the button and the air conditioner will start. Press the button again and the air conditioner will stop.
9	FAN SPEED CONTROL BUTTON
	Press this button to select the fan speed, Low or Middle or High, of your choice.

10	TEMPERATURE SETTING BUTTON
	Use this button for SETTING TEMPERATURE. (Operates with the front cover of the remote controller closed.)
11	SIGNAL TRANSMITTER
	This sends the signals to the indoor unit.
12	TEMPERATURE ADJUSTMENT/ PROGRAMMING TIMER BUTTON
	Use this button for temperature setting and programming “START and/or STOP” time. (Operates with the front cover of the remote controller opened.)
13	TIMER MODE START/STOP BUTTON
	Refer to page 9.
14	TIMER RESERVE/CANCEL BUTTON
	Refer to page 9.
15	AIRFLOW DIRECTION ADJUST BUTTON
	Refer to page 8, 9.
16	OPERATION MODE SELECTOR BUTTON
	Press this button to select OPERATION MODE. “  ” (COOLING), “  ” (HEATING), “  ” (AUTOMATIC), “  ” (FAN), “  ” (PROGRAM DRY).
17	FILTER SIGN RESET BUTTON
	Refer to the section of MAINTENANCE in the operation manual attached to the indoor unit.
18	INSPECTION/TEST OPERATION BUTTON
	This button is used only by qualified service persons for maintenance purposes. Do not operate this button during normal use.
19	EMERGENCY OPERATION SWITCH
	This switch is readily used if the remote controller does not work.
20	RECEIVER
	This receives the signals from the remote controller.
21	OPERATING INDICATOR LAMP (Red)
	This lamp stays lit while the air conditioner runs. It flashes when the air conditioner is in trouble.
22	TIMER INDICATOR LAMP (Green)
	This lamp stays lit while the timer is set.
23	AIR FILTER CLEANING TIME INDICATOR LAMP (Red)
	Lights up when it is time to clean the air filter.
24	DEFROST OPERATION LAMP (Orange)
	Lights up when the defrosting operation has started. (For cooling only type this lamp does not turn on.)

NOTES

- For the sake of explanation, all indications are shown on the display in **Fig. 1** contrary to actual running situations.
- **Fig. 1-2** shows the remote controller with the front cover opened.
- If the AIR FILTER CLEANING TIME INDICATOR LAMP lights up, clean the air filter as explained in the operation manual attached to the indoor unit.
After cleaning and reinstalling the air filter, press the FILTER SIGN RESET BUTTON on the remote controller. The AIR FILTER CLEANING TIME INDICATOR LAMP on the receiver will go out.
- The DEFROST OPERATION LAMP will flash when the power is turned on. This is not a malfunction.
- Do not place the remote controller where subject to direct sunlight. The display of the remote controller will get discolored and may fail to display information.

[CAUTIONS]

Make sure to turn off the unit and disconnect the power supply breaker when taking care of the air conditioner.

Unless the power supply is disconnected, it may cause electric shocks and injuries.

4. HANDLING FOR WIRELESS REMOTE CONTROLLER

[Precautions in handling remote controller]
Direct the transmitting part of the remote controller to the receiving part of the air conditioner.
If something blocks the transmitting and receiving path of the indoor unit and the remote controller as curtains, it will not operate.

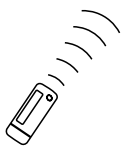
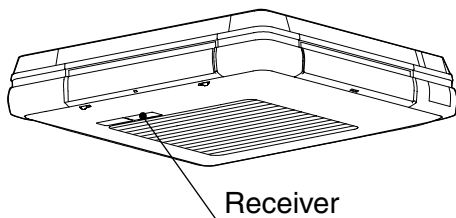

2 short beeps from the receiver indicates that the transmission is properly done.

Transmitting distance is approximately 7 m.

Do not drop or get it wet.

It may be damaged.

Never press the button of the remote controller with a hard, pointed object.

The remote controller may be damaged.

Installation site

- It is possible that signals will not be received in rooms that have electronic fluorescent lighting. Please consult with your local dealer before buying new fluorescent lights.
- If the remote controller operated some other electrical apparatus, move that machine away or consult your local dealer.

Placing the remote controller in the remote controller holder.

Install the remote controller holder to a wall or a pillar with the attached screw.

Placing the remote controller

Slide from above

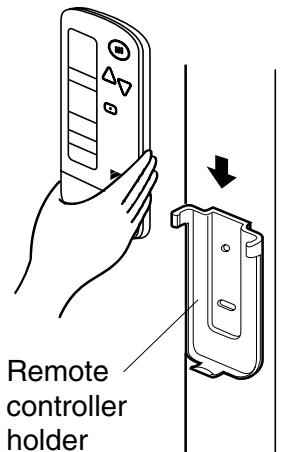

Removing the remote controller

Pull it upward

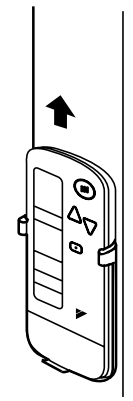

How to put the dry batteries

- (1) Remove the back cover of the remote controller to the direction pointed by the arrow mark.
- (2) Put the batteries
Use two dry cell batteries (AAA.LR03 (alkaline)). Put dry batteries correctly to fit their (+) and (-).
- (3) Close the cover

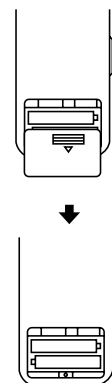

— When to change batteries —

Under normal use, batteries last about a year. However, change them whenever the indoor unit doesn't respond or responds slowly to commands, or if the display becomes dark.

[CAUTIONS]

- Replace all batteries at the same time, do not use new and old batteries intermixed.
- In case the remote controller is not used for a long time take out all batteries in order to prevent liquid leak of the battery.

IN THE CASE OF CENTRALIZED CONTROL SYSTEM

If the indoor unit is under centralized control, it is necessary to switch the remote controller's setting. In this case, contact your local dealer.

5. OPERATION RANGE

If the temperature or the humidity is beyond the operation range*, safety devices may work and the air conditioner may not operate, or sometimes, water may drop from the indoor unit.

* Refer to the operation range shown in the operation manual attached to the indoor or outdoor unit.

6. INSTALLATION SITE

Refer to the operation manual attached to the indoor unit.

7. OPERATION PROCEDURE

Refer to Fig. 1 on page [1]

- Operation procedure varies with heat pump type and cooling only type. Contact your local dealer to confirm your system type.
- To protect the unit, turn on the main power switch 6 hours before operation.
- Do not shut off the power supply during seasonal use of the air conditioner.
This is required in order to activate the air conditioner smoothly.
- If the main power supply is turned off during operation, operation will restart automatically after the power turns back on again.

COOLING, HEATING, AUTOMATIC, FAN, AND PROGRAM DRY OPERATION

Operate in the following order.

- AUTOMATIC OPERATION can be selected only by Heat pump split system and VRV Heat recovery system.
- For cooling only type, "COOLING", and "FAN" and "PROGRAM DRY" operation are able to select.

Refer to Fig. 1-1, 2 on page [1]

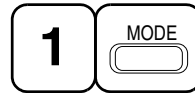

OPERATION MODE SELECTOR

Press **OPERATION MODE SELECTOR BUTTON** several times and select the **OPERATION MODE** of your choice as follows.

- **COOLING OPERATION** "❄️"
The recommended temperature setting is 26 to 28°C.
- **HEATING OPERATION** "☀️"
The recommended temperature setting is 18 to 23°C.
- **AUTOMATIC OPERATION**..... "⏸️"
 - In this operation mode, COOLING/HEATING changeover is automatically conducted.
 - The AUTOMATIC OPERATION controls the temperature based on the temperature setting, so it maintains a comfortable temperature throughout the year, and enables energy-saving operation.
<Example>
When the indoor temperature decreases to 25°C or less when the temperature setting is at 27°C in the AUTOMATIC COOLING OPERATION, the operation is changed over to the AUTOMATIC HEATING OPERATION. When the indoor temperature reaches 29°C or more, the operation is changed over to the AUTOMATIC COOLING OPERATION.
- **FAN OPERATION** "🌀"
Air in the room is circulated.
- **PROGRAM DRY OPERATION** "🏠"
 - The function of this program is to decrease the humidity in your room with the minimum temperature decrease.
 - Micro computer automatically determines TEMPERATURE and FAN SPEED.
 - This system does not go into operation if the room temperature is below 16°C.



ON/OFF

Press **ON/OFF BUTTON**.

OPERATING INDICATOR LAMP (Red) lights up or goes off and the system starts or stops OPERATION.

- When the HEATING OPERATION is stopped, FAN OPERATION is performed for 1 minute to remove heat in the indoor unit.

NOTE

- Do not turn OFF power immediately after the unit stops. Then, wait no less than 5 minutes. Water is leaking or there is something else wrong with the unit.
- After settings are changed or operation is turned ON/OFF, make sure that the receiving tone of the indoor unit makes a beeping sound.

■ CHARACTERISTICS OF THE COOLING OPERATION (COOLING OPERATION AND AUTOMATIC COOLING OPERATION)

- If the COOLING OPERATION is used when the indoor temperature is low, frost adheres to the heat exchanger of the indoor unit. This can decrease the cooling capacity. In this case, the system automatically switches to DEFROST OPERATION for a while. During DEFROST OPERATION, the low fan speed is used to prevent the discharge of melt water. (The remote controller displays the fan speed that is set.)
- When the outside temperature is high, it takes some time until the indoor temperature reaches the set temperature.

■ CHARACTERISTICS OF THE HEATING OPERATION (HEATING OPERATION AND AUTOMATIC HEATING OPERATION)

START OF OPERATION

- It generally takes a longer time for indoor temperature of the HEATING OPERATION to reach the set temperature compared to the COOLING OPERATION. It is advisable to start operation in advance using the TIMER OPERATION.

Perform the following operation to prevent heating capacity decrease and discharge of cool air.

AT THE START OF OPERATION AND AFTER DEFROST OPERATION

- A warm air circulating system is employed, and therefore it takes some time until the entire room is warmed up after the start of operation.
- The indoor fan runs to discharge a gentle wind automatically until the temperature inside the air conditioner reaches a certain level. At this time, the DEFROST OPERATION LAMP on the light receiving unit indicator lights. Leave it as it stands and wait for a while. (The remote controller displays the fan speed that is set.)
- The air discharge direction becomes horizontal to prevent a draft of cool air to the inhabitants. (The remote controller will display the set airflow direction.)

DEFROST OPERATION (Frost removal operation for the outdoor unit)

- As the frost on the coil of an outdoor unit increase, heating effect decreases and the system goes into the DEFROST OPERATION.
- The warm air stops, and the DEFROST OPERATION LAMP on the light receiving unit turn on. (The remote controller displays the fan speed that is set.)
- After maximum 10 minutes of the DEFROST OPERATION, the air conditioner returns to the HEATING OPERATION.
- The airflow direction becomes horizontal. (The remote controller displays the airflow direction that is set.)
- During or after the DEFROST OPERATION, white mist comes out from the air inlet or outlet of the air conditioner.
- A hissing and “Shuh” sound may be heard during this particular operation.

Regarding outside air temperature and heating capacity

- The heating capacity of the air conditioner declines as the outside air temperature falls. In such a case, use the air conditioner in combination with other heating systems. (When a combustion appliance is used, ventilate the room regularly.)
Do not use the combustion appliance where the air from the air conditioner is blown directly toward it.
- When the warm air stays under the ceiling and your feet are cold, we recommend that you use a circulator (a fan to circulate the air inside the room). For details, consult your local dealer.
- When the indoor temperature exceeds the set temperature, the indoor unit discharges a gentle breeze (switches to gentle wind). The airflow direction becomes horizontal. (The remote controller displays the fan speed and airflow direction that are set.)

■ CHARACTERISTICS OF THE PROGRAM DRY OPERATION

- This operation lowers the humidity without lowering the indoor temperature. The indoor temperature when the operation button is pressed will be the set temperature. At this time, the fan speed and temperature are set automatically, so the remote controller does not display the fan speed and set temperature.
To efficiently lower the indoor temperature and humidity, first use the COOLING OPERATION to lower the indoor temperature, and then use the PROGRAM DRY OPERATION. When the indoor temperature is lowered, airflow from the indoor unit may stop.
- When operating continuously at downward airflow direction, air blows in the automatically set direction for a period of time to prevent condensation on the horizontal blades.
- If the PROGRAM DRY OPERATION is used when the indoor temperature is low, frost forms the heat exchanger of the indoor unit. In this case, the system automatically switches to the DEFROST OPERATION for a while.

ADJUSTMENT

For programming TEMPERATURE, FAN SPEED and AIRFLOW DIRECTION, follow the procedure shown below.

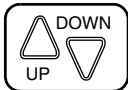

TEMPERATURE SETTING

Press **TEMPERATURE SETTING BUTTON** and program the setting temperature.

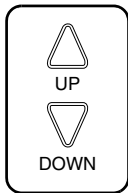

Each time this button is pressed, setting temperature rises 1°C.

Each time this button is pressed, setting temperature lowers 1°C.

- Temperature can not be set in the FAN operation.

In case of automatic operation

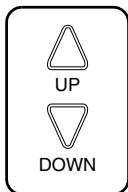

Each time this button is pressed, setting temperature shifts to "H" side.

Each time this button is pressed, setting temperature shifts to "L" side.

[°C]

	H	■	M	■	L
Setting temperature	25	23	22	21	19

- The setting is impossible for FAN operation.

NOTE

- The setting temperature range of the remote controller is 16°C to 32°C.
- After settings are changed or operation is turned ON/OFF, make sure that the receiving tone of the indoor unit makes a beeping sound.



FAN SPEED CONTROL

Press **FAN SPEED CONTROL BUTTON**.

Low, Middle or High fan speed can be selected.

- The micro computer may sometimes control the fan speed in order to protect the unit.
- The fan speed may be changed automatically depending on the indoor temperature. The fan may be stopped, but this is normal.
- It may take some time until the airflow switch is completed, but this is normal.
- The fan speed cannot be set to "automatic".



AIRFLOW DIRECTION ADJUST

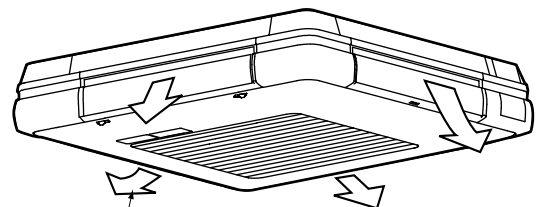

Up and down adjustment

Press the **AIRFLOW DIRECTION ADJUST BUTTON** to select the airflow direction as shown below.

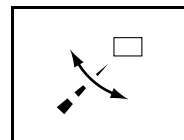

DISPLAY appears and the airflow direction continuously varies. (Automatic swing setting)



Press **AIRFLOW DIRECTION ADJUST BUTTON** to select the air direction of your choice.



DISPLAY vanishes when the airflow direction is fixed (Fixed airflow direction setting).

MOVEMENT OF THE HORIZONTAL BLADE

For the following conditions, micro computer controls the airflow direction so it may be different from the display.

Operation mode	<ul style="list-style-type: none"> • COOLING • AUTOMATIC COOLING • PROGRAM DRY 	<ul style="list-style-type: none"> • HEATING • AUTOMATIC HEATING
Up and down direction	<p>Air blows in the automatic set direction for a period of time to prevent condensation on the horizontal blades.</p> <ul style="list-style-type: none"> • When operating continuously at downward airflow direction 	<p>The airflow direction becomes horizontal so that it does not blow directly toward your body.</p> <ul style="list-style-type: none"> • When room temperature is higher than the set temperature • When the HEATING OPERATION starts or during DEFROST OPERATION (if frost forms on the outdoor unit)

PROGRAM TIMER OPERATION

Operate in the following order.

- The timer is operated in the following two ways.
 - Programming the stop time (⊕ · ○)
 - The air conditioner stops operating after the set time has elapsed.
 - Programming the start time (⊕ · |)
 - The air conditioner starts operating after the set time has elapsed.
- The start and the stop time can be simultaneously programmed.
- The timer setting is effective only once. When using the TIMER operation every day, the setting is required before each use.

1



TIMER MODE START/STOP

Press the TIMER MODE START/STOP BUTTON several times and select the mode on the display.

The display flashes.

For setting the timer stop “⊕ · ○”

For setting the timer start “⊕ · |”

2



PROGRAMMING TIMER

Press the PROGRAMMING TIMER BUTTON and set the time for stopping or starting the air conditioner.

 UP

When this button is pressed, the time advances by 1 hour.

 DOWN

When this button is pressed, the time goes backward by 1 hour.

- Keep pressing the button to change the setting time continuously.
- The timer can be programmed a maximum of 72 hours.

3



TIMER RESERVE

Press the TIMER RESERVE BUTTON.

The timer setting procedure ends.

The display changes from flashing light to a constant light.

- Make sure that the receiving tone of the indoor unit makes a beeping sound. If the receiving tone does not sound, press the TIMER CANCEL BOTTON, and then set the timer using steps ① to ③ again.

4



TIMER CANCEL

Press the TIMER CANCEL BUTTON to cancel programming.

The display vanishes.

- Make sure that the receiving tone of the indoor unit makes a beeping sound. If the receiving tone does not sound, set the timer using steps ① to ③, and then press the TIMER CANCEL BUTTON again.

For example.

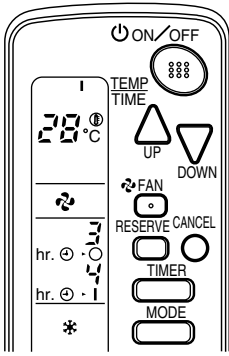

When the timer is programmed to stop the system after 3 hours and start the air conditioner after 4 hours, the air conditioner will stop after 3 hours and then 1 hour later the air conditioner will start.

NOTE

- After the timer is programmed, the display shows the remaining time.

EMERGENCY OPERATION

When the remote controller does not work due to battery failure or the absence thereof, use the switch in the suction grille of the indoor unit. When the remote controller does not work, even if the batteries are replaced, contact your local dealer.

[START]

1 Press the **EMERGENCY OPERATION SWITCH**.

- The air conditioner operates in the previous mode.
- The air conditioner operates with the previously set fan speed.

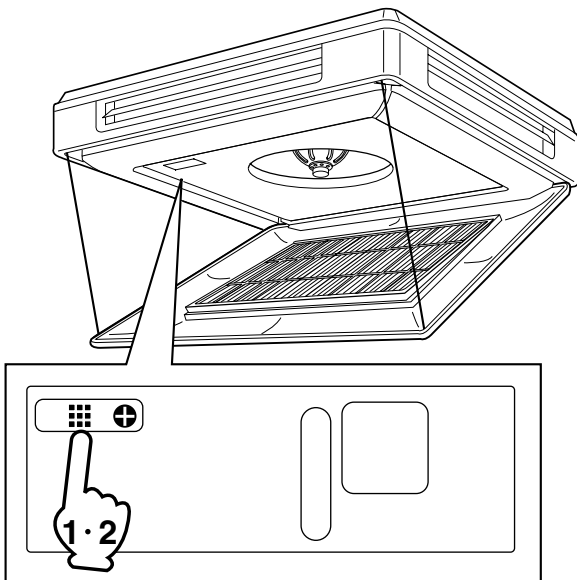

This display is located next to the air outlet of the indoor unit. (Refer to Fig. 2-1 on page [1])

[STOP]

2 Press the **EMERGENCY OPERATION SWITCH** again.

PRECAUTIONS FOR GROUP CONTROL SYSTEM OR TWO REMOTE CONTROLLER CONTROL SYSTEM

This system provides two other control systems beside individual control (one remote controller controls one indoor unit) system. Confirm the following if your system is of the following control system type.

■ Group control system

- One remote controller controls up to 16 indoor units.
- All indoor units are equally set.

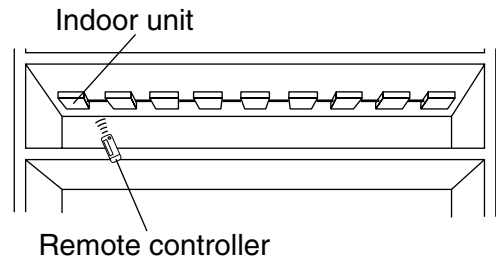

■ Two remote controller control system

Two remote controllers (wired and wireless) control one indoor unit. (In case of group control system, one group of indoor units)
The air conditioner follows individual operation.

- Cannot have two remote controller control system with only wireless remote controllers. (It will be a two remote controller control system having one wired and one wireless remote controllers.)
- Under two remote controller control system, wireless remote controller cannot control timer operation.
- While the two remote controller control is operating, the wireless remote controller displays the OPERATION MODE only.
- If the wired remote controller is used for operation, the display on the wireless remote controller does not change.

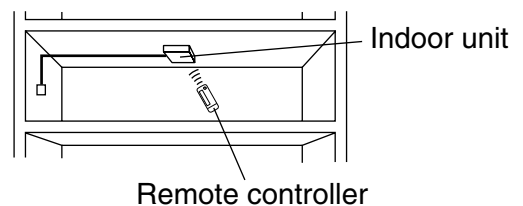

NOTE

- Contact your local dealer in case of changing the combination or setting of group control and two remote controller control systems.
- Please do not change the combination and settings for the group operation and two remote controller control systems by yourself, but be sure to ask your local dealer.

8. OPERATION CHARACTERISTICS

Refer to the operation manual attached to the indoor unit.

9. OPTIMUM OPERATION

Refer to the operation manual attached to the indoor unit.

10. MAINTENANCE (FOR SERVICE PERSONNEL)

Refer to the operation manual attached to the indoor unit.

11. NOT MALFUNCTION OF THE AIR CONDITIONER

Refer to the operation manual attached to the indoor unit.

And the following symptoms do not indicate air conditioner malfunction

I. THE AIR CONDITIONER DOES NOT OPERATE

- The receiving tone of the indoor unit makes a triple beeping sound (normally, “beep-beep”).

This is because the air conditioner is under centralized control.

- After the HEAT OPERATION is started, the DEFROST OPERATION LAMP located on the indoor unit lights up.

The indoor fan runs to discharge a gentle wind automatically until the temperature inside the air conditioner reaches a certain level. At this time, the DEFROST OPERATION LAMP on the light receiving unit indicator lights. Leave it as it stands and wait for a while.

II. COOLING AND HEATING OPERATIONS CAN NOT BE SWITCHED

- The receiving tone of the indoor unit makes a long beeping sound.

An unavailable mode was set for the indoor unit under operation changeover control.

III. THERE IS NO DISPLAY OR ALL PARTS ARE DISPLAYED

- When a button on the remote controller is pressed.

The batteries have run out.

12. HOW TO DIAGNOSE TROUBLE SPOTS

I. EMERGENCY STOP

When the air conditioner stops in emergency, the OPERATING INDICATOR LAMP on the indoor unit starts blinking.

Take the following steps yourself to read the malfunction code that appears on the display. Contact your local dealer with this code. It will help pinpoint the cause of the trouble, speeding up the repair.

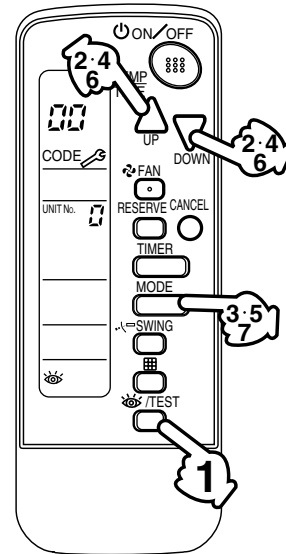

Press the INSPECTION/TEST OPERATION BUTTON to select the inspection mode “”.

“” appears on display and blinks.

“UNIT No.” lights up.



Press PROGRAMMING TIMER BUTTON and change the unit number.

Press to change the unit number until the indoor unit beeps and perform the following operation according to the number of beeps.

Number of beeps

3 short beeps Perform all steps from **3** to **6**.

1 short beep Perform **3** and **6** steps.

1 long beep Normal state

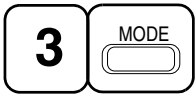

Press **OPERATION MODE SELECTOR BUTTON**.

“**1**” on the left-hand of the malfunction code blinks.

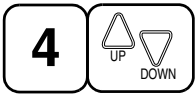

Press **PROGRAMMING TIMER BUTTON** and **change the malfunction code**.

Press until the indoor unit beeps twice.

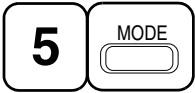

Press **OPERATION MODE SELECTOR BUTTON**.

“**7**” on the right-hand of the malfunction code blinks.



Press **PROGRAMMING TIMER BUTTON** and **change the malfunction code**.

Press until the indoor unit makes a long beep.

The malfunction code is fixed when the indoor unit makes a long beep.

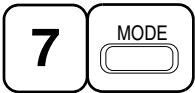

Reset of the display

Press **OPERATION MODE SELECTOR BUTTON** to get the display back to the normal state.

II. IN CASE BESIDES EMERGENCY STOP

1. The air conditioner does not operate at all.

- Check if the receiver is exposed of sunlight or strong light. Keep receiver away from light.
- Check if there are batteries in the remote controller. Place the batteries.
- Check if the indoor unit number and wireless remote controller number are equal.

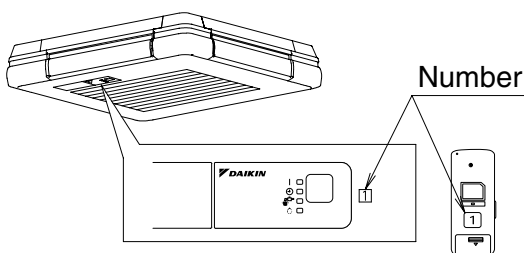

Operate the indoor unit with the remote controller of the same number.

Signal transmitted from a remote controller of a different number cannot be accepted. (If the number is not mentioned, it is considered as “1”.)

2. The air conditioner operates but it does not sufficiently cool or heat.

- Check if the set temperature is not proper. (Refer to page 8)
- Check if the FAN SPEED is set to LOW SPEED. (Refer to page 8)
- Check if the airflow direction is not proper. (Refer to page 8)

If the problem is not solved after checking the above points, please do not try to repair it yourself. In such cases, always consult your local dealer. At this time, please tell the symptom and model name (written on the manufacturer’s label).

Contact your local dealer in the following case.

— **WARNING** —

When you detect a burning odor, shut OFF power immediately and contact your local dealer. Using the equipment in anything but proper working condition can result in equipment damage, electric shock and/or a fire.

[Trouble]

The OPERATING INDICATOR LAMP of the indoor unit is flashing and the unit does not work at all. (Refer to page 4)

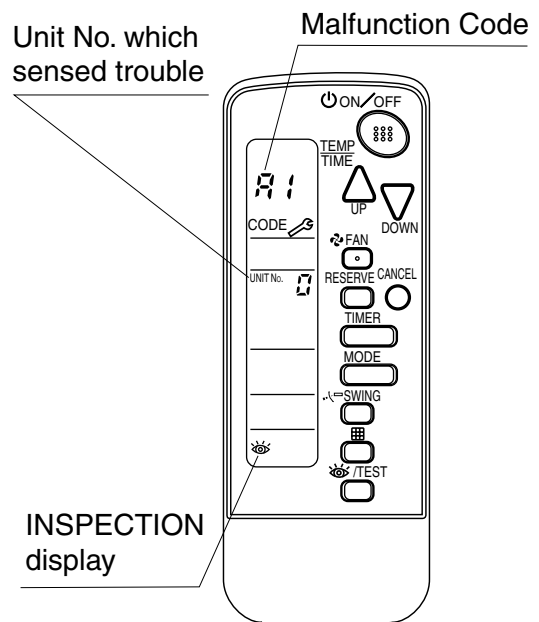

[Remedial action]

Check the malfunction code (A1 - UF) on the remote controller and contact your local dealer. (Refer to page 11)

DAIKIN INDUSTRIES, LTD.

Head office:
Umeda Center Bldg., 2-4-12, Nakazaki-Nishi,
Kita-ku, Osaka, 530-8323 Japan

Tokyo office:
JR Shinagawa East Bldg., 2-18-1, Konan,
Minato-ku, Tokyo, 108-0075 Japan

DAIKIN EUROPE N.V.

Zandvoordestraat 300, B-8400 Oostende, Belgium